

# THE HOME STUDIO HANDBOOK

PRESENTED BY  **DISC MAKERS®**

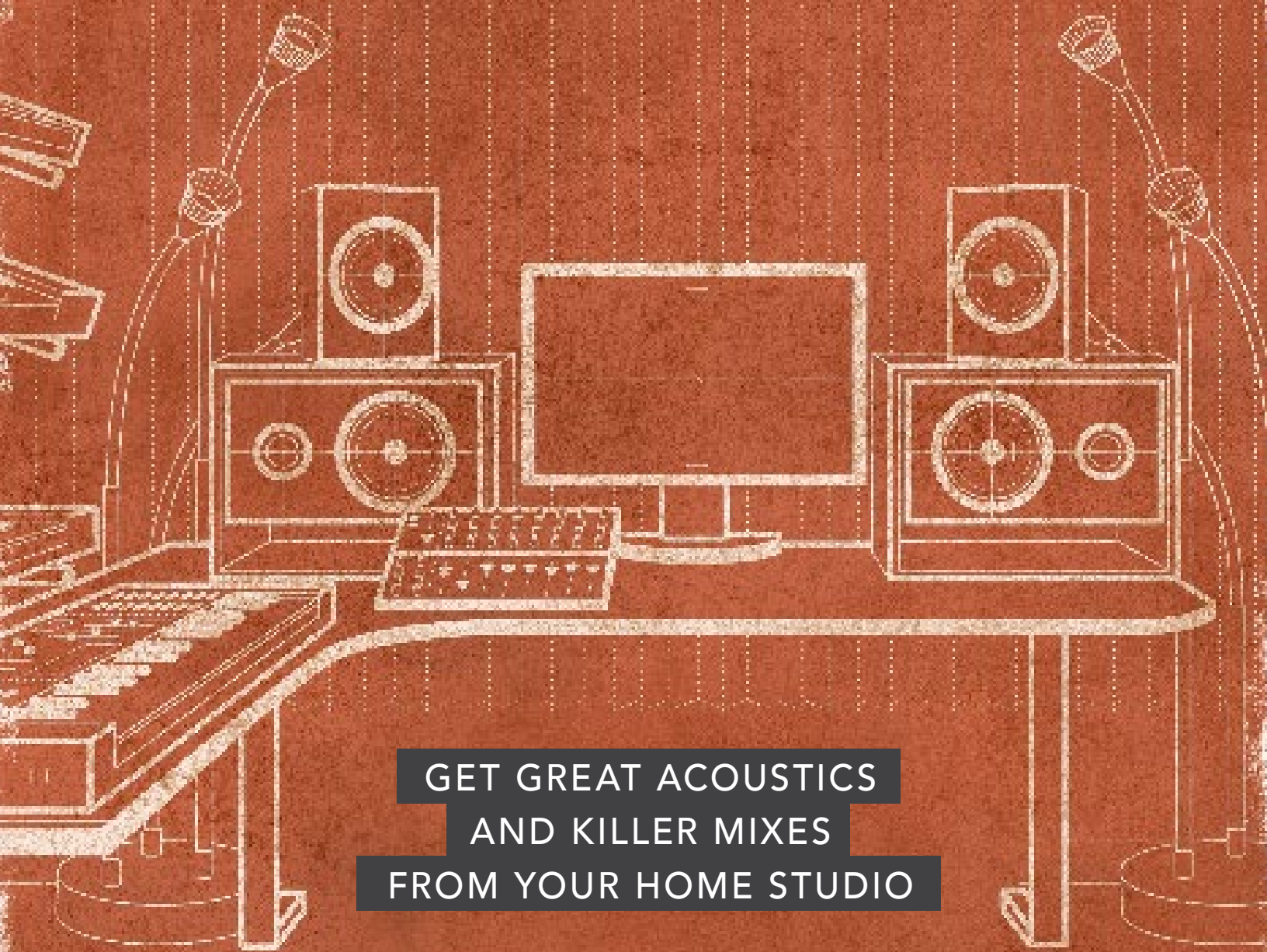

GET GREAT ACOUSTICS  
AND KILLER MIXES  
FROM YOUR HOME STUDIO



# ACOUSTICS & YOUR HOME STUDIO

GET OPTIMAL RESULTS FROM YOUR SPACE & BUDGET

**I**f you decide to convert space in your home to function as a project studio, it's easy to spend a lot of money before you plug in your first microphone. While quality recording gear is more affordable than ever, acquiring everything you need to start recording adds up, and that doesn't begin to address the costs of properly outfitting your space.

For many home recording enthusiasts, doing any sort of construction is simply not an option—but that doesn't mean your dream of a recording space in your home needs to end before it begins. The degree to how "professional" your studio needs to be, and therefore how expensive the endeavor, is relative to your goals for your finished product. At the same time, your budget will ultimately determine how ambitious you can be within the scope of the project.

## YOU CAN START BY ANSWERING THESE FOUR BASIC QUESTIONS:

### 1. What is the purpose of your home studio?

Are you recording new ideas to demo to your band or producer? Recording, mixing, and mastering finished tracks to submit to a music supervisor? Is this your band's DIY album for distribution and sale? Are you planning to record other people's material? Deciding on the reason you are getting into home recording is the first step toward setting realistic goals.

As a general rule, the more musicians and acoustic instruments you intend to record, the more expansive your studio will need to be in regard to space, equipment, and gear. In addition, the number and type of live instruments you intend to track will dictate the requirements of your acoustic environment.

### 2. What space do you have available?

You need to find the best available distraction-free environment. Your garage may seem like a natural location to set

up your home studio, but if it's always damp and it houses a boiler, washer, and dryer—or you live on a street with busses rumbling back and forth throughout the day—it's probably not your ideal space.

Very often, a spare bedroom or home office makes for a good home studio environment—though bear in mind that distractions abound at home. Normal sounds like the doorbell, phone, bathroom fan, or heating/AC system can be the death of a perfect take. Do your best to isolate yourself from household sounds wherever you decide to record.



JON MARC WEISS' KIVA PRODUCTIONS STUDIO IN HOLLYWOOD, PA.

### 3. Are you planning to record a full band or one or two musicians at a time?

The spare bedroom might be perfectly isolated, but can you house your gear, monitors, amps, and microphones and still have ample room to perform comfortably? What if you're tracking two musicians at once? Or three? The physical dimensions of your available space are contributing factors to your ambitions for your project studio.

### 4. Are you using your space for overdubs and mixing, or are you planning to track everything in your studio?

This will ultimately be the biggest decision you make before you start down the road to researching, purchasing, and installing your home recording set up. But the truth is, to get a professional sound out of something like a drum kit, you'll need space, you'll need to manage the acoustics in your room, and you'll need lots of mics and stands. These purchases add up and will deplete a modest budget very quickly.

## YOU'RE WORKING ON A BUDGET, AFTER ALL

"One thing I often recommend to home recording enthusiasts is, don't outfit your home to do the big work," says Philadelphia-based producer/engineer Drew Raison. "If you have a limited budget to build a studio, why invest in all the necessary microphones, microphone stands, and cables? You start there and you could be well into thousands of dollars.

"Let somebody else spend that money. Go to a studio that's already outfitted with all the accoutrements, cut the drums and have the engineer transfer the tracks to a stereo mix so you can overdub guitars, bass, and vocals at home. If you have a limited amount of money, why not put it into a vocal recording system? Get the correct microphone for an acoustic, get the best microphone for an electric, and cut all that at home. You can leave the big, multi-channel recording to a professional studio."

## CONTROLLING THE ACOUSTICS

Whatever your expectations, a major component to creating quality finished recordings in a home environment is controlling the acoustics. To really do things right, it starts with the construction of the room, including the proper angles of the walls and ceiling, the proper room dimensions, and state-of-the-art acoustical room treatments placed in the appropriate places. These are but a few of the things that set a professional studio apart from your rehearsal space and bedroom.

The first step toward achieving an acoustic environment that will produce great results at home is understanding some of the basic principles of how sound

waves work and how to control the way they inhabit and interact in a room.

When a sound wave meets a surface—a wall, a couch, a desk—some of the wave is **absorbed**, some of it is **reflected**, and some of it gets transmitted through the surface. Most dense surfaces do a good job **isolating** sound, but will reflect sound back into

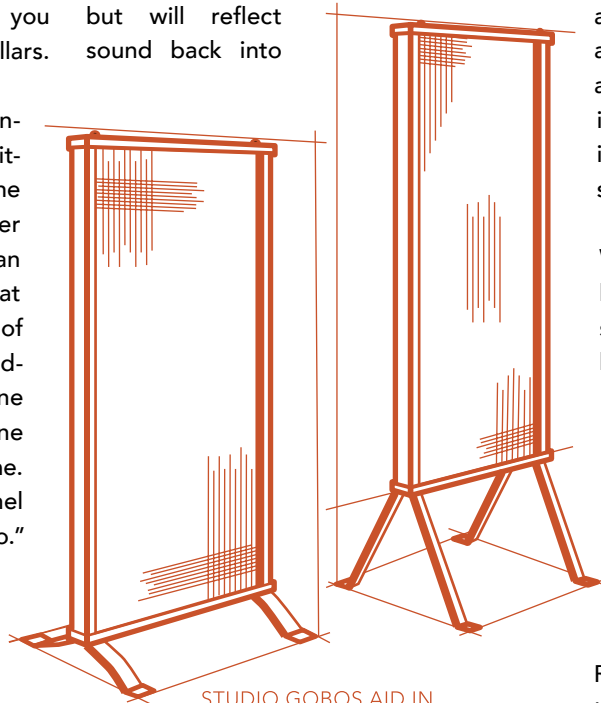

STUDIO GOBOS AID IN LOWER FREQUENCY ABSORPTION.

the room. Porous surfaces typically absorb sound well but also **transmit** sound.

The best way to stop sound transmission—sound leaking in or out of a room—is to isolate sound from the structure before it has a chance to vibrate. In other words, walls need to be isolated from ceilings and floors, achieved by **decoupling**—referred to as "floating" a room.

But floating a room is precisely the type

of construction effort that isn't an option for most people. So what can you do?

## ROOM ARRANGEMENT

Assuming you're not building a separate control room, you'll be configuring all your equipment in your designated studio space. So your first task is to envision where you'll be housing your monitoring station and board. If you've got the budget and are really looking to optimize the acoustics and sound of your home studio, consulting a professional at the outset is a good idea, complete with diagrams and dimensions of the space you have to work with.

Where your mixing/recording station will be is something that needs to be envisioned specifically for the space you're in, but you should try to keep your listening position somewhere close to the middle third of the room—it is very difficult to hear accurately with a wall directly behind you. There are also certain rules to follow in regard to monitor placement.

"You want to come as close to an isosceles triangle as you can," says Raison. "That's the proportion of the distance between the speakers to where the engineering sweet spot is. It's a comfortable listening angle, but it's also a time thing. Sound and time go hand in hand, so you want to make sure that they're evenly balanced. If the speakers are 10 feet apart, you should be sitting 10 feet back.

"Another thing: don't place a monitor in the corner. In most rooms, if you're in the center of the wall, you're in great shape. But if you take the table and move it to the corner, then you have one monitor that will sound boomy and the sound gets mushy and imbalanced."



LONG WAVELENGTH:  
LOW FREQUENCY, LOW SOUND, FEWER WAVE CYCLES.

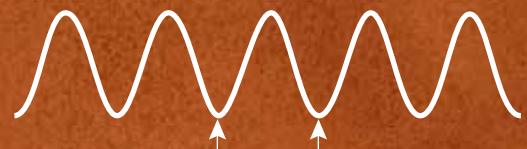

SHORT WAVELENGTH:  
HIGH FREQUENCY, HIGH SOUND, MANY WAVE CYCLES.



STUDIO:469, DESIGNED BY DREW RAISON.

### EARLY REFLECTION POINTS

Sound bouncing off the walls and floors and surfaces in your room needs to be addressed as the **reflections** will cause problems. One fix is to address the reflected sound waves in your environment by adding sound-absorbing wall treatments. A controlled, deliberate approach, using professional sound absorption and diffusion products, will yield the best results.

Chances are the room you're considering has 90-degree angled corners. The walls are parallel, as are the floor and ceiling—not the ideal acoustic environment. To improve the acoustics, start with the **early reflection** points.

"Once the direct sound from the monitors has passed by you, you want something behind you to either soak it up or shatter it all over the place," says Raison. "In either case, you don't want a direct early reflection to hit your ears too soon. If it does, it will completely smear what you are hearing and it will give you problems. It's those early reflective points you want to knock out.

"One trick is to use a pocket mirror. If you have a pair of speakers on a desk in the middle of a wall and the speakers are sitting on that desk, you can look around the room and see what reflective points you're going to have. Points on the walls, and also the ceiling and the floor—those initial reflection points are my first go-to spots for sound absorption. When we're treating a room, I'll sit in the engineer's seat and have someone move a pocket mirror along the wall until I can see the speaker reflected in the mirror. That's where you want to put up some sort of an acoustical absorption product.

"It's the early reflection points on the ceiling, floor, or desk that most people overlook. Even applying just a thin absorptive membrane on the ceiling can help knock down those highs and mids that can cause the early reflection smearing. You're not trying to keep low frequencies from bouncing off that ceiling, you probably don't have the time or space to do that, so to speak. Just don't overlook the ceiling. People typically don't do things to ceilings in the regular world, but in a recording environment it makes a substantial amount of difference."

### 50% RULE

When it comes to optimizing the acoustics in a room, you don't want to deaden down everything. You want a room that has **ambience** to it, otherwise what you record and what you hear won't be accurate, and your finished recordings will suffer. Every room is different, but applying a 50% rule is a solid launching point.

"In a square or rectangular room, I'd recommend covering 50% of the surface area," Raison advises. "For example, do 1'x1' pyramid foam squares in a checkerboard pattern on every wall—cover your 50% that way. And it counts on the ceiling, too. 50% would be great, but if you can't do that, make sure you get that early reflection spot. It will knock down the reflections to a degree that they won't get in your way and cause monitoring issues.

"You just need to remember, when you're recording in a home studio and you're recording drums in a bedroom, you have all these early reflections that are going to bleed into every microphone and create unpleasant anomalies like **comb filtering** or **flutter**

**echoes**. If you have a room with parallel walls and you take a super ball and you whip it at the wall, it's going to go 'bounce bounce bounce' back and forth—that's a flutter. And if you clap your hands in a live room, you can hear a flutter. That can kill a recording. That's why we do the acoustic absorption on the walls, to cut that flutter down."

### BASS TRAPS

Sound bounces back and forth between hard, parallel surfaces, and lower frequency sound waves are longer than high frequencies. For instance, a bass guitar playing a low E at 41Hz produces a wave roughly 27.5 feet in length, while a piccolo playing at 3500Hz produces a wave that's less than four inches long. Acoustic foam effectively absorbs reflected sound, and thicker acoustic foam is better at absorbing low-frequency sounds.

The panels and wall hangings used to absorb the early reflection points are going to help with the mid and high-mid frequencies, but when it comes to preventing lower frequencies from reflecting and causing cancellations and boominess in your recording/listening environment, using bass traps and denser sound absorbers behind your monitoring point is recommended.

Since low-frequency resonances have their points of maximum (or minimum) pressure in a room's corners, **bass traps** are often triangular in shape to fit into corners, though studio gobos are also common for lower frequency absorption as well. Remember, once the sound has passed by your ears, soaking up the sound behind you is critical so you won't be coping with sound reflecting from behind you.



# GETTING STARTED

## MAKE THE MOST OF YOUR STUDIO TIME & SPACE

**I**f you're recording in a home studio, even if you take the time and effort to address basic acoustics, chances are your room isn't going to compete with a pro studio environment. There may be some instances where capturing the room's ambience and resonance is just what you want, and other times where isolating your sound source and divorcing it from the room is your better option.

In every studio environment, there are simple things you can do to maximize the quality of your sound sources, get the best performances from your players, and record the best possible sounds and tones in your studio space.

### FOCUS ON YOUR INSTRUMENT

Even in the hands of the best player, an instrument with bad intonation won't sound good on record. Maintaining and preparing an instrument is the first step to producing a quality recording.

If you're a vocalist, warm up and do your vocal exercises before hitting the mic. Drinking warm tea and honey to lubricate your vocal cords can help, as will wearing a scarf around your neck to keep your cords warm, avoiding smoking and dairy to keep your throat moist and phlegm free, and avoiding loud environments prior to your recording date where you might tax your vocal cords.

If you're a guitar player, change your strings before going into the studio—especially if it's an acoustic guitar. If you're a bass player and you don't change your strings once a month, you should consider changing those strings before you bring your bass into the studio. In both cases, it will help the tone and the output, and you'll stay in better tune.

If you're a drummer, change all your drum heads before recording. If the heads have

been on for too long, they're going to sound dull and they're not going to stay in tune. Also, take time to tune the drums correctly—you may even consider tuning the drums differently for different songs.

As a performer preparing to record, make sure you're rehearsed and comfortable with the parts you'll be recording, and make sure you enter the studio well-rested and with a clear head.

### CHECK YOUR CABLES

Good cables can make a big difference, so make sure they all work and don't rely on cheap product. Make sure all your input jacks and connections are working, and use a can of spray air to clean out any pots or faders that might have dust built up.

### CREATE A COMFORTABLE, BUT FUNCTIONAL, ENVIRONMENT

For artists who do not have a lot of experience in the studio, the transition from a rehearsal or performance environment to the studio can be very uncomfortable. As a producer/engineer, creating an environment that is physically and emo-

tionally accommodating can go a long way to improving the mindset and potential for performance from your talent.

"I had one session with a young woman," recalls engineer, producer, and studio owner Jon Marc Weiss, "she was a vocalist, and her dad and her husband were there. We just couldn't get a good take out of her. Her dad was totally on her, he was saying things like, 'When you're in front of your mirror in your bedroom, you do such a good take, and then we come into the studio and you can barely perform!' Part of the problem was that they were putting way too much pressure on her. You're not going to get a great performance out of anyone that way.

"In addition to that, she was obviously in a comfortable environment and relaxed in her own room—so we brought the mirror, and her bedside table, and candles from her room, and we arranged them in the studio. Believe it or not, it worked! She just needed something familiar to make her feel at home. You've got to be careful as an engineer not to make it too clinical and sterile. You've got to keep the



smiles going and keep the vibe going.”

### EXPERIMENT

There is one constant, true for all recording studios and situations: keep experimenting. The only way to know what sounds good and what to avoid in your home studio is to try different approaches to the same scenario. So much of the art of engineering, producing, and recording comes from trial and error and constantly honing your ears and your technique.

“I’ve learned a lot watching creative engineers at work,” says Drew Raison. “Steve Albini worked in my studio, and he was laying microphones just above floor level. There’s an evil little echo, that **first reflection** echo you are typically trying to avoid. He wanted to harvest that. To me, that was a huge question mark. Why would you want to do that? And then I heard it and I was like, ‘Well, boy, there it is.’ It is an acquired taste, but his management of acoustic space was eye-opening.

“I rarely use what I learned from him in my

own recordings because I’m not looking for a radical departure from a given tonality, but you should never hesitate to experiment. This is your opportunity. Analyze and decide, ‘Did this work or didn’t it?’ and ‘What can I do to make it better next time?’ That’s what makes a home recording enthusiast become a producer over time.”

### KEEP IT SIMPLE

Don’t run too many devices in series with one another. Limiting the number of components in your chain will usually provide a fatter tone. If you’ve got a **mic preamp**, an **EQ**, and a **compressor** in the signal chain, you’re probably doing that for a reason, but sometimes that can negatively affect the sound. If you’re not happy with the tone you’re getting on record, try going right out of the preamp into the console and deal with the EQ and compression later. Sometimes simplicity is the way to go, and getting a more natural tone recorded should be the goal.

### GET IT HOT, HOT, HOT

Always try to get the hottest signal you can on record. If you don’t, you’re missing out

on some of the sound from the source. Get the level as hot as you can without going over. Some A/D converters have a feature called a **soft limit**, which can help with this.



“Let’s say you have a really dynamic part, a section of the song where the vocalist is hitting it a little too hard,” explains Weiss. “You can try to anticipate the trouble spots and pull the gain down on the preamp a little, or you can use soft limiting. It’s kind of like compression but it just limits the output of the digital signal.”

### TARGET YOUR FREQUENCY

When you’re recording and mixing, you don’t want to have lots of overlapping frequencies. If you’re cutting percussion, for instance, and you don’t need anything below 80 Hz, you can use a **high pass filter** and allow the highs to pass through while cutting off the low frequencies so you’re focusing that instrument into the frequency range you want it to occupy in the mix.

Maybe the air conditioner that’s blowing air in your direction is producing low-frequency rattle, or the artist who’s tapping her foot or moving around in the studio is producing low-frequency energy that doesn’t need to be recorded. A high pass filter can also eliminate those frequencies from the recording.

Conversely, if you’re recording bass guitar, you probably don’t need all the top end, so take some off the top with

 There is one constant, true for all recording studios and situations: keep experimenting. The only way to know what sounds good and what to avoid is to try different approaches to the same scenario. 

a **low pass filter**. Filtering out the frequencies that don't need to be there will help keep the mix articulate and clean.

### DON'T JUMP TO EQ

Sometimes, the low end or highs that you're not capturing (or that you have too much of) are a result of poor mic placement, using the wrong mic, **EQ** settings on the instrument or amp, or the angle of the mic in relation to the instrument. Adjusting any one (or more) of these elements can make a big difference without having to touch the EQ, especially if you're trying to capture more high end. Pushing the high end on an EQ can bring unwanted noise into the track and the mix.

Much of the art in recording comes from mic use, placement, and angle. A lot can be accomplished by adjusting the angle of the mic and testing multiple placements for tone, both in relative distance to the sound source and where the mic is pointing.

### GAIN STAGING

**Gain staging** is another way to get different tones from the same source. Here's one example: Take a microphone, something with a little versatility—e.g. a 10 db pad and a bunch of pickup patterns—and then experiment.

If you're cutting jazz or something orchestral and you want something clean and natural sounding, you won't need to use a pad on the mic. But that doesn't mean you shouldn't experiment.

"For a different tone," says Weiss, "try pushing the preamp. Use the pad and crank the gain on the preamp. Now it's as if the preamp is waiting for the sound, ready to suck it in like a vacuum, and that recorded tone is vastly different than if you aren't taxing the preamp. One thing that sets pro engineers apart is they know how to hit their gear. They know they can get different tones by having the gain in different places."

### LIMIT COMPRESSION AND EQ WHEN RECORDING

While many engineers will use some compression and EQ when recording, be cognizant that the decisions you make at the time of recording will remain with that

track. Some things can be undone, but others can't, and if you over-compress or over-equalize, you're largely going to be stuck with it. When you're recording, make it your priority to acquire the performance to the best of your ability. Then when you're mixing, make the critical decisions regarding **compression**, **EQ**, and other effects.

"If you're not making pop music or something geared to the radio," says Raison, "then none of this really matters and you should follow your own vision. But if you want the world to hear your music and you're working in a home studio, I recommend you keep it simple. Minimal equalization and minimal compression at the time of recording, because you can add that later. Try not to make unfortunate decisions at the time of recording."

### AVOID PHASE CANCELLATION

While recognizing and avoiding **phase cancellation** takes experience and understanding, using a 3-to-1 ratio is a good place to start in your home studio when using more than one microphone to capture a sound source. 3-to-1 means the second microphone should be three times (or more) the distance from the source than the first microphone. Bear in mind, if the sound source or your microphone is close to a **reflective wall**, that could cause another phase cancellation. In a gigantic empty space, the 3-to-1 rule generally works. It also works in a smaller space, but you have to deal with other **artifacts** like **early reflections**, **reverberation** in general, **standing waves**, and **nodes**.

"An out-of-phase signal can cause

instruments to disappear from your mix if somebody's speakers are wired incorrectly," says Raison. "In a home environment, you have to be doubly aware of this because you're working in smaller spaces and potentially have greater possibility of phase problems."

"If you're using a computer for your home recording, there are phase correlation meter plug-ins that will show you the health of your phase in your stereo field. If you're working outside of a computer environment, you have to be able to recognize it, and that takes a set of ears. A trick that sometimes works is to flip the phase on one of the channels in your mix and then put the mix in mono. Most stand-alone units have a mono button, so if you flip the phase on either your left or right channel, and you put it in mono, you'll hear if things disappear. Typically it's the stuff down the middle that disappears, which in my world means the stuff that splits evenly between right and left—bass guitar, kick drum, snare drum, lead vocal."

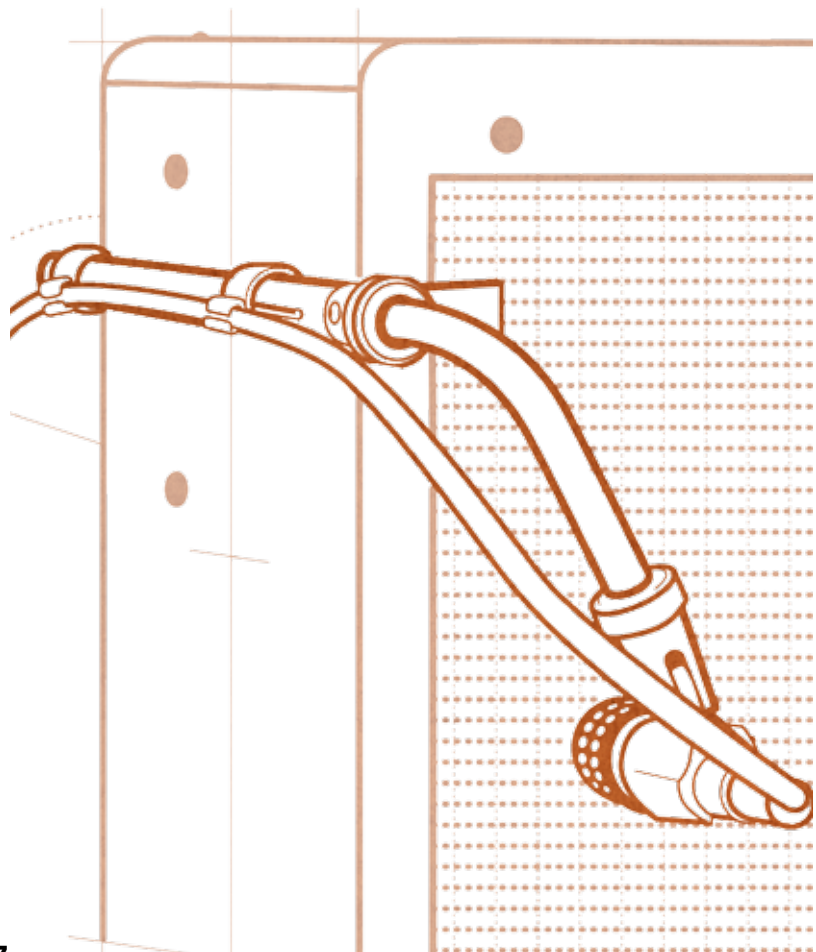



# RECORDING TIPS FROM THE PROS

## TECHNIQUES TO IMPROVE YOUR RECORDINGS

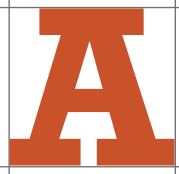

As we've already touched on, experimenting is the best way to determine the recording techniques that work best for you and your studio. There are many basic rules, and definite acoustic anomalies you need to be aware of (and typically avoid), but being good at capturing tones and sounds is largely a matter of practical experience.

That said, as someone working in a home studio environment, don't be afraid to bring in external resources to help you record—a little bit of money can go a long way. If you can't execute the recording of a drum part because of space or microphone limitations, cut the drums in a local studio and have them give you a stereo mix to work with. If you need help recording vocals, working with an experienced engineer will help you better understand the process and enable you to hit the mark on your own the next time you record.

Of course, you're ready to record *now*—so here are some basics to keep in mind to help you make the most of your home recordings

### MOVE AROUND THE ROOM

Before you hit record and capture an instrument's tone to tape for posterity, take the time to physically move the instrument or amplifier to different parts of the room and listen to how it sounds. Playing an instrument in different parts of the room can make a big difference in the tone. If you're recording an acoustic guitar, violin, piano, sax, or any acoustic instrument, and you play it near a wall with a lot of glass and wood, you'll get a more reflective sound than if you're up against a baffle. If you're recording an amp, play around with different spots until you get the right tone for the track.

### ANGLE YOUR AMP

Raising an amp off the ground or angling it can have dramatic effects on the tone, depending on the room and the amp. The floor may be wood, and it may have a resonant cavity below that's affecting your

low end, or adding more because it's vibrating. By pulling the amp off the floor and putting it on a stand, essentially you're **decoupling** it. Even if you're angling it, only part of the amp is touching the floor, so you're basically removing the floor from the equation in terms of the tone.

"If you have an amp perpendicular to the floor, all the energy is going forward, and low to the ground," says Weiss. "Let's say you've got an 8-foot ceiling. You've got many more mic placement options if the amp is kicked up at a 45-degree angle. Now you can put a mic up in the corner to get more of the room. If you're going for a really tight sound, you might just want to leave it on the floor, focus the energy, and take the room out of the equation. A professional studio is going to have a floor built specifically so that it won't have pockets of resonance underneath. Your home studio probably won't be as predict-

able, so finding the right spot and the proper angle can make an enormous difference."

### PLAY WITH MIC PLACEMENT AND ANGLES

Mic placement and mic angles go a long way toward capturing different tones from the same sound source. For example, to help record a very **sibilant** vocal performer, try angling the mic up toward a 45-degree angle and you might find a lot of that popping and hissing goes away. Just by taking a microphone and adjusting it 10 degrees—or just a little bit to the left or the right—can make an enormous difference in the tones and sounds you capture on record.

"If you are recording a guitar cabinet," says Raison, "the sweet spot will vary from cabinet to cabinet. When you consider a speaker is a diaphragm that is physically moving air, bear in mind that the sound emanates



from that angled cone—no sound comes from the center of the speaker. Aim the mic at the cone portion of it, or inwards or outwards, upwards or downwards, off-axis a little, or towards the cabinet away from the speaker—in every single case, you will get a different kind of a tone.”

#### GET THE AIR MOVING

If you’re recording with a computer, there are hundreds of software plug-ins that can emulate the sound of an array of guitar and amplifier combinations in a variety of ambient settings. But in the end, speaker emulators simply can’t push the air and do what a speaker does. Even in the most basic situations, if you put an instrument through a 10” or 12” cabinet, it will make a significant differ-

ence in the tonality of the instrument as compared to going directly from a rack-mount effects processor or a computer plug-in.

#### FOCUS THE ENERGY

“If you’re in a home studio environment and you don’t have a lot of control over the acoustics in your room,” says Weiss “you can end up capturing a lot of unwanted **early reflections**, **flutter echo**, and the like. To get a sound that’s more direct, try taking sleeping bags, blankets, or cushions off your couch and build a little space, like a fort or a teepee, and put the microphone in it. You probably want to avoid using acoustic foam treatments for this, as you could lose too much high end. But something to focus the energy and cut out the **ambients** can help

you capture the source more effectively.

“Another way to get a tighter, more controlled sound and get less of the room is to use a filter, like the [Auralex Mud-Guard](#). For \$150, it will create a baffle around the microphone and focus all of the energy into the mic so you pick up virtually no reverberation from the room.”

#### MULTIPLE MICS

“Before you consider using multiple mics in your studio, ask yourself how much experimentation you want to do,” warns Raison. “It may not be worth the extra work, as a single microphone can usually get the job done. When you introduce a second or third microphone into the equation, you’re intro-



If you’re recording an acoustic guitar, violin, piano, sax, or any acoustic instrument, and you play it near a wall with a lot of glass and wood, you’ll get a more reflective sound than if you’re up against a baffle. If you’re recording an amp, play around with different spots until you get the right tone for the track.



ducing potential **phase anomalies**, e.g. two microphones picking up similar signals and canceling each other out. One microphone is safe and easy, with two or more microphones there are rules you have to follow, and they're not necessarily going to get you a better or radically different sound."

### RE-AMPING

Re-amping is a recording technique that can salvage or spruce up tracks recorded in a home studio or less-than-ideal recording environment. It's also a great way to experiment with sounds and tones without having to constantly re-record a part. You can even totally reinvent a part without compromising the original track. The basic idea is to take a recorded track, send the signal to studio monitors or an amplifier, set up a mic, and record the "re-amped" track.

#### Add ambience

Let's say you've got something recorded, you love the performance, but in playback you're realizing it's just a little too dry—it needs a bit of room ambience. You can always go to a digital reverb or delay, but if you want to experiment, or you want a sound that's just different from the effects in your software or outboard repertoire, re-amping is another option.

Play the track through studio monitors and put a mic on the other side of the room, or even a room or two away, and pick up the natural ambience on a new track. Mix that in and you've added breadth to the original. If you're working in a digital environment, you can move that reverb around and control where the **ambient** track sits in relation to the original track.

This can be a particularly handy technique for recording drums in a project studio. Often a home studio environment is not ideal for recording drums—it might be too small a room, or too controlled—which can leave you with a dry and lifeless drum track. In such a case, bring up the kick, snare, and toms in the monitor and put a microphone down a hallway. You'll capture a splashy, boomy sound that you can't really get with a digital reverb.

"I've gone as far as to put a mic one room

away, and then another two rooms away, and use those different tracks on the left and right for a stereo effect," says Weiss. "I worked on this one project where they were recording in an apartment, and the drums weren't cutting it. I ended up sticking a mic in the shower, which was adjacent to where they were cutting the tracks, pulled up the kick, snare, and toms through the monitors, and all of a sudden it sounded like the drums were cut in a huge, beautiful sounding room."



AURALEX'S MUDGUARD

#### Amp swapping

Sometimes you just don't have the means to capture the guitar sound you have in your head or the tone you originally recorded just isn't knocking your socks off, but the performance is killer. Maybe the recorded bass tone doesn't have the body you need to hold its place in the mix. Re-amping can be your solution to salvage that great performance.

Taking a clean guitar track and sending it to an amplifier gives you a lot of room to

experiment with tone and effects—and you're using the actual recorded performance to get your sound, so there are no surprises when you hit the red button. Taking the direct-signal recording of a bass track and sending that through an amp provides the same opportunities.

The same applies to just about any instrument you can think of—re-amping through a live amplifier is going to give you a number of options not necessarily available at the time you recorded the performance. There aren't any rules—you're doing this to get a vibe, create a sound, and capture something special or different. Experimenting can yield some great and unexpected results.

"Re-amping is another way a lot of home recording enthusiasts use my studios," adds Raison. "They'll record everything at home, bring their tracks in, and we feed that signal through a vintage Marshall or a vintage Vox. And they take the bass and we feed it through a vintage SVT cabinet all miked up with the expensive stuff as a way to punch up what they have."

#### Getting creative

"There was a guy who had me mix a number of songs for him, and the agreement was that he was just going to leave me alone and take whatever I came up with," explains Raison. "He gave me this one guitar solo that was done on a nylon string classical guitar. I ended up compressing the daylights out of it, feeding it through a full guitar rig, and bringing it back into the system and affecting it. It was a classical guitar solo that ended up sounding like an Aerosmith track, and it worked great. I had actually done the same thing with a cello. I ran that through a Marshall rig trying to emulate a Deep Purple kind of a tone—it was awesome."

"I've seen a situation where we were recording drums," adds Weiss, "and there just wasn't enough of the snare sound, we didn't get that rattle. So we took the snare track, sent that through an amp, and placed the snare drum next to the amp. Every time the snare hit, the live drum would rattle, and we were able to record the snare rattle we missed in the first pass."

# 4

## THE HOME STUDIO MICROPHONE GUIDE

FINDING THE RIGHT MICS FOR EVERY SITUATION & EVERY BUDGET

# A

fter the instrument—and the player—the microphone is arguably the most important element in the recording chain, as the microphone and your mic placement techniques are the means of capturing the sounds you are recording.

There are different types of microphones, but they share a few things in common. All are transducers, converting acoustic energy (sound) into electric energy, or an audio signal. In addition, every microphone has a diaphragm, which vibrates when sound waves move the air and converts those vibrations into an audio signal.

One thing that sets mics apart is the price tag. As a rule, the type of mic, the quality and expense of the components, the artistry involved in crafting the mic, and the science behind the construction all factor into the final price. And while a higher-quality microphone does tend to result in a higher price tag, there are many gems that outperform their contemporaries in similar (and sometimes higher) price ranges and others that are simply better-suited to particular situations.

### TYPES OF MICS

Mics are categorized by the type of element used: condenser, electret (condenser), ribbon, and dynamic. There are a number of other types of mics (carbon, piezoelectric, fiber optic), but condensers, ribbons, and dynamic mics are the mainstays of music recording.

#### Condenser microphones

Very popular for all types of recording situations, condenser microphones provide a very accurate representation of the source. They work well on quiet and subtle sound sources, like an acoustic guitar, and can also pick up loud sound sources, like a drum kit, without losing detail.

A condenser mic houses one or two electrically charged plates, usually Mylar sputtered with gold or nickel, and built into most is a transformer. Because they are electrically charged—through a battery, phantom power, or in the case of electrets, by the electric

charge inherent in the mic's materials—a condenser's capsule is very active and sensitive to even slight pressure fluctuations, which is the main reason condensers are so accurate.

There are different sized condenser mics, and it's the size of the diaphragm that dictates the area of concentration. In general, a one-inch diaphragm mic is ideal for vocals and other instruments where you're trying to pick up the low end. Small diaphragm condensers have a diaphragm that's anywhere from ½ to ¾ inch and are a good choice for instruments that have a lot of high-end energy, such as an acoustic guitar. You will often find small diaphragm mics set in a stereo pattern.

Different model condensers all have different characteristics: some have multiple pickup patterns, low-frequency roll-offs, attenuator pads—some of them are tube, some of them are FET (field-effect transis-



INSIDE THE AKG C414 XLS (IMAGE BY AKG).

tor), some are transformerless, with and without IC (integrated circuit) chips, and they all produce a very different sound.

Condensers are not commonly used in live situations as they generate feedback fairly easily and are more fragile than a dynamic microphone. Moisture or a good knock from a drumstick can permanently damage a condenser mic.

### Ribbon microphones

Ribbon mics go back to the late '20s when RCA embraced the technology and made it popular. Think of those images of Frank Sinatra standing in front of the RCA 77DX, the

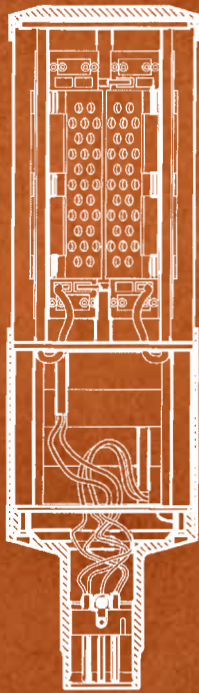

A DIAGRAM OF A STEREO RIBBON MICROPHONE.



DURABLE DYNAMIC MICS LIKE THE SM 58 ARE GREAT FOR STUDIO AND STAGE APPLICATIONS.

pill-shaped mic that was incredibly popular from the '30s through the late '60s. Ribbons were a studio staple through the mid-'60s.

The use of ribbons faded for a number of reasons. You need a very strong preamp to use them, ribbon mics tend to be on the more expensive side of the scale, and most notably, they are quite fragile. Drop a ribbon mic, blow into it, or slam a door in a tight room and the element is broken and it's off to the shop. The element is literally a pressed ribbon of corrugated material (usually aluminum) stretched across a magnet, and that thin ribbon is liable to break with any amount of air pressure. Ribbon mics are still fragile, compared to dynamic mics and even condensers, but windscreen technology has advanced to make them less prone to destruction.

A ribbon mic is not the most versatile mic, but what makes them so enduring is their midrange detail. Ribbons were, and still are, very popular for some types of vocalists, but what they were predominantly used for in their heyday were horns. A saxophone, and most every brass instrument, has a signature midrange that plays to a ribbon mic's sweet spot.

### Dynamic microphones

Dynamic mics were originally designed to be a replacement for ribbon mics because they can handle high sound pressure levels (SPL) and can handle being thrown around. Dynamic mics don't have nearly the character or articulation of a condenser, but they are very resilient to damage, even if they're dropped.

Dynamic mics are probably the most commonly used mic (think Shure's SM 57). Dynamic mics are relatively inexpensive, and there are a host of uses for them, including recording drums, guitar cabinets, bass cabinets, horns... almost everything. In a studio, you won't usually see them on vocals or acoustic guitar, or anything that has a lot of detail in the top end, though there are notable exceptions to this rule.\* In a live setting, a huge percentage of the mics being used are going to be dynamic. They're designed to withstand a ton of abuse and keep feedback in check.



OMNIDIRECTIONAL

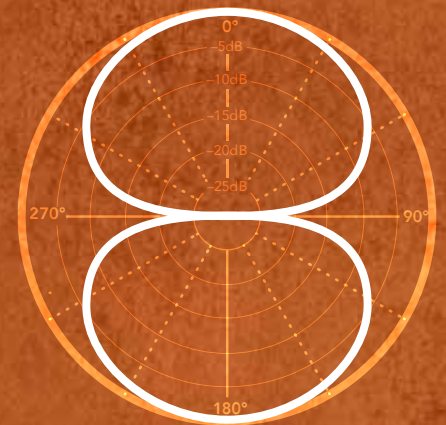

BI-DIRECTIONAL (FIGURE-8)

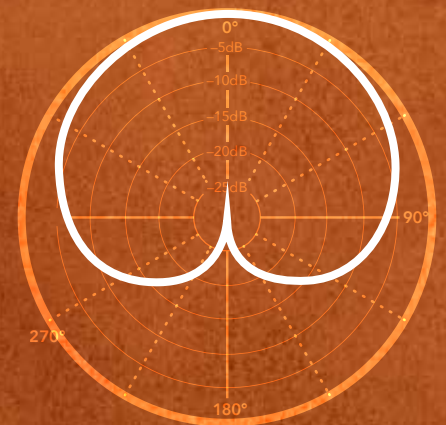

CARDIOID

\*Bruce Swedien, who engineered the bulk of Michael Jackson's catalog, used a Shure SM7B to record Jackson's vocals on the Thriller album. Metallica and the Red Hot Chili Peppers have used the same mic, and the list goes on. The fact that these industry giants choose a \$400 dynamic microphone for vocals is the ultimate case-in-point that a higher price tag doesn't always mean it's the right mic for the job.

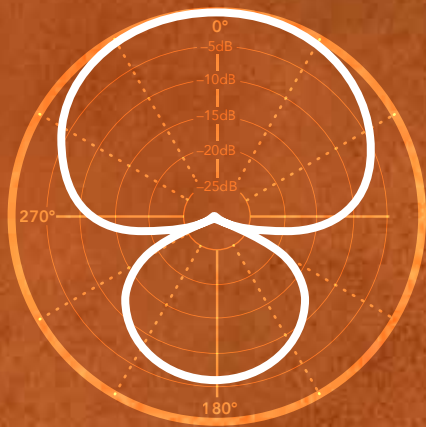

HYPER-CARDIOID



SUPER-CARDIOID

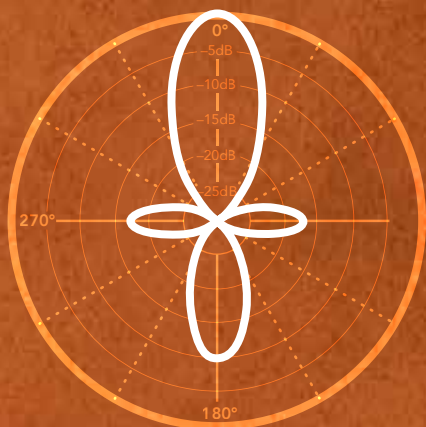

UNIDIRECTIONAL

### Pickup patterns

A microphone's pickup, or polar, pattern refers to the breadth of its area of concentration. In other words, it refers to how sensitive the microphone is to picking up a sound source relative to its central axis. Most mics have a fixed pattern, though some studio mics include a range of pickup pattern choices by way of a switch on the mic. (Polar Pattern images © Galak76)

### Omnidirectional

An omnidirectional pattern will pick up 360 degrees around its element. If you have one mic and you want to pick up everything going on in the room, like a choir or a circle of singers or strings, an omni mic setting is the one to use.

### Bi-directional (Figure-8)

A bi-directional (or Figure-8) mic will pick up sound sources equally from the front and back of the mic. A bi-directional mic has two elements, one is negatively charged and the other positive. Most ribbon microphones have a bi-directional pattern, which is useful if you have two sound sources you want to record, like a duet of singers or instruments.

### Cardioid

Cardioid is a tighter pickup pattern that gets its name from the heart-shaped pattern seen in the diagram. The most popular mic pickup pattern, cardioid mics will pick up sound sources in a fairly wide range from the front of the mic, will taper out sources not directly in front, and have almost no sensitivity to sounds coming directly from the rear of the mic. This helps reduce feedback and focuses on the sound source.

### Hypercardioid

Compared to a cardioid pattern, a hypercardioid microphone has a tighter area of front sensitivity plus a small area of rear sensitivity.

### Super-cardioid

A super-cardioid pattern is similar to a hypercardioid, with a slightly larger area of concentration in the front and a thinner area in the rear.

### Unidirectional

A unidirectional pattern has extreme off-axis rejection, meaning it will only pick up sound sources that are directly in front of the microphone.

### Shotgun

A shotgun mic is a unidirectional mic designed to pick up things that are far away, with a high degree of focus, so as not to pick up sources it isn't directly pointed at. They're typically electret condensers and are often used for TV and field recording, though they can be used to isolate instruments in a studio setting, like a bass drum or piano.

### Pressure Zone Microphone (PZM)

While they perform a very specific function, PZMs are not typically used in the studio. Most often, a PZM is an omnidirectional mic mounted to a plate, so the mic picks up all the reflections of the sound in an awkward space (e.g. inside a closed piano).



There are different types of microphones, but they share a few things in common. All are transducers, converting acoustic energy (sound) into electric energy, or an audio signal. In addition, every microphone has a diaphragm, which vibrates when sound waves move the air and converts those vibrations into an audio signal.



# BEYOND THE PICKUP PATTERN

ADDITIONAL PICKUP PATTERNS CAN BE ACHIEVED USING MULTIPLE MICROPHONES:



## XY

Small or large diaphragm condensers, crossed at a 90-degree angle, provide a wider pickup pattern than you'll get from a single mic. Often used for a stereo field, but sometimes just used for coverage on a drum kit or a piano, for instance.



## MS (Mid-Side)

The MS technique is slightly complicated, but ultimately provides more control over the width of the stereo spread than the XY configuration. A cardioid or hypercardioid mic is set facing the sound source (the "mid" mic), then a bi-directional mic is aimed 90 degrees off axis from the source (the "side" mic) and placed above the mid mic, as close as possible.

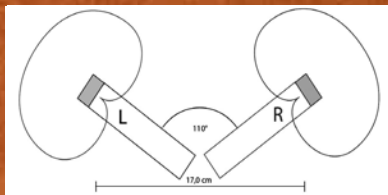

## ORTF

Devised in the '60s at the Office de Radiodiffusion Télévision Française (ORTF), this technique uses two cardioid mics mounted on a stereo bar, typically 17 cm apart at a 110-degree angle. This technique can be used to create depth in the stereo field for a single instrument, or used in mono to create a wider pickup pattern. Rather than using multiple mics around a room, you can use this technique to limit and control the width of your pickup pattern.

# NEW LOW PRICES!

For a limited time we've lowered prices on all our most popular CD packages!



Get a free quote: [discmakers.com/products](http://discmakers.com/products)

# 29 MIC PICKS FOR THE HOME STUDIO (and beyond)

## UNDER \$100



### Behringer C-1 \$50

CONDENSER (LARGE DIAPHRAGM)

For anyone working with a small budget, this cardioid mic delivers crisp, clear voice recordings and accurate reproduction of acoustic instruments.



### Shure SM 57 \$99

DYNAMIC

The cardioid dynamic microphone you see on so many different instruments and applications. Its versatility is a big plus. It's also very rugged, dependable, and incredibly affordable. "SM" stands for "studio microphone," as this was originally to be an alternative to the notoriously fragile ribbon mics. The [Beta 57A](#) (\$139) is a brighter supercardioid version, providing more warmth, presence, and a higher output level.



### Shure SM 58 \$99

DYNAMIC

The sibling of the SM 57 includes the ball grille with the foam lining to provide an extra degree of pop and wind protection. Its durability has made it a live performance staple. The supercardioid [Beta 58A](#) (\$159) is designed to be a live vocal mic, but its studio applications can be likened to the SM 57 and Beta 57A.



### Audio Technica AT2020 \$99

CONDENSER (MEDIUM DIAPHRAGM)

This medium diaphragm condenser was designed with the home studio owner in mind. Use it to record vocals, acoustic instruments, strings, or as an overhead mic for drums



### MXL 990 \$75

CONDENSER (MEDIUM DIAPHRAGM)

A cardioid condenser that is quiet and smooth with enough mids to cut through the mix when recording vocals, acoustic guitar, and piano.

## \$250-\$500



### Rode NT3 \$269

CONDENSER (SMALL DIAPHRAGM)

Cardioid condenser recommended for acoustic guitars, percussion, and anything where you're looking to capture mids and highs.



### Audio Technica AT4022 \$349

CONDENSER (SMALL DIAPHRAGM)

Omnidirectional condenser at an affordable price — well-suited for mid-range frequencies. As with any omnidirectional mic, a good acoustic environment is key to capturing great tones.



### Sennheiser MD 421 II \$380

DYNAMIC

Cardioid mic with a five-position bass roll-off switch, which allows you to filter out unwanted low frequencies. Good mic for live and recording situations, particularly for bass drum, brass, and narration.



### Shure SM7B \$399

DYNAMIC

Classic cardioid vocal mic with bass roll-off and an impressive resume, including many of Michael Jackson's most famous vocal recordings. Also widely used in broadcasting.



### AKG D12 \$500

DYNAMIC

The D12 VR is a large diaphragm cardioid dynamic microphone. Specifically designed for recording kick-drum, this mic is widely used for bass guitar as well.

## \$500-\$1,000



### Rode NTK \$529

CONDENSER (LARGE DIAPHRAGM)

A cardioid vacuum tube condenser that works equally well on flutes and vocals (it was used on vocals for Nickelback's *Long Road*). Described as "warm" and "flattering" without adding its fingerprint to the recorded track. Its sister, the [Rode K2](#) (\$699) has multiple polar patterns and sounds particularly good on acoustic guitar.



### Audio Technica AT4050 \$699

CONDENSER (LARGE DIAPHRAGM)

A condenser with three polar patterns — omnidirectional, bi-directional, and figure-8 — this mic can handle walloping sound levels and is suited for vocals, acoustic instruments, and loud percussion.



### Beyerdynamic M 160 \$700

RIBBON

Hyper-cardioid mic with two ribbons and a wide range of uses, including strings, horns, electric guitar amps, and drums. Ever hear "When The Levee Breaks" by Led Zeppelin? That's an M 160 on Bonham's drums. Its brother is the [M 130](#) (\$699) a figure-8 (bi-directional) dual ribbon microphone.



### Neumann KM 184 \$849

CONDENSER (SMALL DIAPHRAGM)

A studio staple cardioid condenser described as "accurate and exceptional" on all things stringed. Best used in rooms with good acoustics as its accuracy can accentuate your room's trouble spots, particularly if there are any extraneous sound sources (computers, fans, etc.).



### Shure KSM 44A \$999

CONDENSER (LARGE DIAPHRAGM)

Multi-pattern (cardioid, omnidirectional, and figure 8) condenser mic that works well on just about any sound source, including piano, acoustic guitar, and strings. Also a nice choice when a little more richness in tone would benefit a vocalist.

## \$1,000-\$2,000



### AKG C414 XLS \$1,075

#### CONDENSER (LARGE DIAPHRAGM)

Featuring nine polar patterns for a wide variety of uses, the C414 is a thoroughbred vocal mic with a long history (it was first introduced in 1971). Also exceptional on acoustic guitar and piano. The [C414 XLII](#) (\$1,100) is an excellent mic for acoustic instruments and one that adds a bit of brightness on guitar amps.



### Royer R-121 \$1,295

#### RIBBON

A figure-8 ribbon mic that delivers clean and warm tones and can take a huge amount of SPL. Use them on everything, from vocals to drums to horns. The [R-10](#) (\$499) is a smaller, less expensive mic, replacing the discontinued R-101. Both have a bi-directional polar pattern, and [Royer has sound clips of the 10 and 121](#) on its website..



### Neumann U 87 Ai \$3,200

#### CONDENSER (LARGE DIAPHRAGM)

Professional studio, multi-pattern (omni, cardioid, figure-8) condenser mic that delivers unparalleled detail and dynamic sound, the U 87's sonic signature can be heard on many hit records. Selected by *Sound on Sound* magazine readers as "the best microphone, period."



### Neumann TLM 103 \$1,300

#### CONDENSER (LARGE DIAPHRAGM)

The next step up from the 102, the TLM 103 is also a cardioid mic used by professional broadcasters and pro studios around the world. Boasting a very natural sound, for a "high-level" home studio, this is a high-quality general-purpose mic.



### sE Electronics Gemini II \$1,699

#### CONDENSER (LARGE DIAPHRAGM)

A dual-tube cardioid condenser that is physically heavy (a big mic with two tubes will tend to be) that provides a balanced sound with good string definition on acoustic guitars and colored, detailed mids on vocals.



### AKG C12 VR \$5,999

#### CONDENSER (LARGE DIAPHRAGM)

The AKG C12's history dates back to the early '50s. Manufactured in Austria, it is widely regarded as the most "exclusive and sought after mic ever built." A vacuum tube mic with nine polar patterns, AKG's C12 VR is a modern take on the original.



### Mojave Audio MA-300 \$1,295

#### CONDENSER (LARGE DIAPHRAGM)

Mojave, which is Royer's non-ribbon division, expanded on the MA-200 tube condenser (a fixed cardioid) to include multiple patterns (continuously variable from omni to figure-8). Use on vocals, as overheads, percussion, and especially acoustic guitar.



### Blue Microphones Kiwi \$1,999

#### CONDENSER (LARGE DIAPHRAGM)

Multiple polar patterns (controlled by a rotary switch) range from omni to cardioid to figure-8 with three intermediate positions in between. The Kiwi is described as "smooth as silk" and is ideal for all kinds of acoustic instruments and percussion and provides clarity in diction for both male and female vocalists.

# PROFESSIONAL MASTERING \$59/TRACK

## What you get with The SoundLAB:

- A sophisticated master tailored to your music.
- The ability to speak with your engineer about your project.
- Your complete satisfaction or your money back.

[discmakers.com/soundlab](http://discmakers.com/soundlab)



The  
**SoundLAB**  
at DISC MAKERS





# MONITORS, PREAMPS & MORE

## THE ESSENTIAL GEAR TO GET YOUR STUDIO OFF THE GROUND



If you've outfitted space in your home for the purpose of recording music, step two is amassing the gear for the task at hand. This section can serve as a checklist for things you already have, need immediately, will put off until later, and what you'll be requesting for birthdays and anniversaries to come.

### CABLES

Cables are a necessary component in any studio, but may be one of those things you overlook when considering how to spend your money. There is a wide range of options—a 20' instrument cable can range in price from \$10 to over \$200. As a matter of practicality, if you're outfitting a home studio, spending hundreds of dollars on a single cable is overkill. What you do want to focus on is using the proper cable for the proper function and not going to the extreme cheap end to save a few bucks.

#### Speaker, Instrument, and microphone cables

An **instrument cable** is built to convey a weak, unamplified signal. Your guitar or bass is putting out a small DC current with a small voltage—that's why it needs amplification. An instrument cable is a low power/high impedance cable with one small diameter (usually 24 gauge) positive wire—typically copper, silver, or aluminum—that carries this weak signal.

The instrument cable is insulated and shielded, or it would pick up noise from external sources that would cause humming or buzzing and could even pick up radio frequencies. In addition to the internal shielding, there is the outer casing and the 1/4" jacks that complete the cable. The quality of the material of all of these components, as well as the quality of the assem-

bly, goes into the cost of your cable.

A **speaker cable** is built to convey a strong signal from an amplifier to a speaker and has two wire conductors, with a relatively large diameter, to allow greater signal flow. Generally speaking, the larger the diameter of the wire, the better the flow of the signal to the speakers. The wires are insulated, encased in a filler, and wrapped in an outer jacket.

A **microphone cable** is also built to carry a relatively weak signal from the microphone and consists of one pair (and sometimes two pairs) of twisted wire. Those cables are insulated, encased in a filler, are shielded (like the instrument cables to prevent external interference), and wrapped in an outer casing.

#### Cable choices

Performers may already have found their instrument cable of choice, and they'll want to use that in a recording situation, but having functional instrument cables on hand is necessary, and buying for quality and longevity are recommended. Depending on the brand and number of cables, you're looking at spending anywhere from \$50 to many hundreds of dollars on instrument cables.

For your studio monitors, investing in de-

cent speaker cables is worthwhile, as is buying the right length. Likely, you'll not need anything much longer than 15 feet, so don't go buying 50-foot cables to plug in your near field monitors. Depending on length and quality, you can spend anywhere from \$30 to \$70 for a pair.

Microphone cables are more difficult to predict—depending on your space and requirements. If you're recording drums and miking a rhythm section at the same time, you could have a need for 15 mic cables. Length comes into play here as well, depending on whether you need to make it to an adjacent room or not.

As such, mic cables can easily add up to hundreds of dollars. Purchasing high-end cables for every mic in your arsenal is probably not practical, so obtaining high-performance cables for acoustic guitar and vocal mics could be worthwhile, and you can get away with something less expensive for electric guitar, bass, and drum mics.

### PREAMP

A mic preamplifier is an electronic amplifier that prepares a weak electrical signal, such as that from an instrument or microphone cable, for further amplification or processing. Because microphones provide a low signal, using a preamp is a way to boost the signal before it gets to the recording con-

sole. This helps with the purity of the signal as well, as the chance of interference can be lessened. By keeping the sound source close to the preamp using a shorter and well-insulated cable, the amplified source will be cleaner, and the **signal-to-noise ratio** is solely dependent on the noise figure of the preamp.

Preamps can also be used as signal boosters for the ubiquitous SM57 and your other workhorse mics for much the same reason. The hotter and cleaner the signal, the better the final result of your recording.

Another use for a preamp is software monitoring. If your DAW or computer doesn't have the processing power to utilize your system's plug-ins on the way in, or if you're taxing your DAW's mixer, you can experience **latency** issues. Using an external preamp will ease the burden on the mixer and improve your working conditions considerably.

Preamps can come equipped with **compressors, equalizers**, channel strips, and the like—and can cost many thousands of dollars—but a simple, single function preamp can run anywhere from \$40-500.

"A quality external mic preamplifier is a great place to put your money," says Reason. "A particular preamplifier might represent a certain colored sound, while another represents a very pure and accurate sound. In my studios, in addition to the various

preamplifiers in the boards, we have 20 or more additional mic amplifiers because each one sounds different. We might use one preamp on bass and another on vocals, this on piano, and this to collect room sounds based on the color and sound each produces. It's a great way to optimize sound in your recording."

### MONITORS

When considering what you want from a monitor, consider this: within your budget, you want something that will give you as clear a vision of what you've recorded as possible. Some of the less expensive monitors have the byproduct of being colored in one direction or another. You can very easily spend more than \$1,000 just on monitors, but if you're relying on your studio to produce final mixes, there are compelling arguments why they are worth that investment. But if you're looking for a solid reference point, you can buy a good pair of monitors and still have room to spare for all the other gear you'll need.

### Unpowered (passive) monitors

Passive monitors need an external source of amplification to boost the signal between the mixer and the monitor. While you may save money on the monitors, it does necessitate the purchase of a power amp. Plenty of options exist, and a search on your favorite gear site will return power amps specifically geared to the task of recording. Make sure your power amp can pump out 50-100% more power than the



speakers require. If your speakers are rated at 120 W at 4 ohms, you'll want a power amp that delivers in the neighborhood of 200 W at 4 ohms.

A power amp in the chain also requires additional cables. A higher-gauge speaker cable (16 gauge or better) is what you need to go from the power amp to the monitors, but you can use 24-gauge cables to go to

## PURCHASING THE RIGHT MONITORS

A lot of what makes a pair of monitors right for you is all about preference. Tweeters and drivers are made out of different materials. Domes can be made of titanium or aluminum, which will be a bit crispy, or Mylar or silk, which are softer. Speaker cone can be made of paper, doped paper, polypropylene, Kevlar, or metal. The enclosure and design of the driver will also contribute to the sound of the speaker (particularly in reproducing bass tone), so hearing a variety of options and choosing the one that best suits your ear is recommended.

Another consideration is having two or more sets of monitors. Being able to A/B from a larger pair of speakers to a smaller pair, for instance, can help give you different perspectives and information on the same mix.

your power amp. There are a host of good options for power amps ranging from \$150-350, and passive monitors start around \$200 a pair and go up into the multi-thousand dollar range.

#### Powered (active) monitors

Active monitors have built-in amplifiers, with separate amps for the separate drivers. Benefits of powered monitors include fewer cables to buy, less space taken up, amps that are perfectly suited to the drivers, and in a good pair of active monitors, the frequency splitting can be more accurate than in a passive system.

When an audio signal is sent to your powered monitors, a crossover splits the signal into the appropriate frequency ranges before they're sent to the individual drivers, and the cabinet houses an amplifier for each driver. The frequency band splitting is performed on the line input signal directly prior to the amplifiers.

Active monitors run in desktop sizes that start at \$79 a pair (for a 10 W speaker). Something comparable to the 120 W passive speakers referenced earlier start in the \$450/pair price range.

#### Purchasing the right monitors

A lot of what makes a pair right for you is all about your own preferences. Tweeters and drivers are made out of different materials. Domes can be made of titanium or aluminum, which will be a bit crispy, or Mylar or silk, which are softer. Speaker cone can be made of paper, doped paper, polypropylene, Kevlar, or metal. The enclosure and design of the driver will also contribute to the sound of the speaker (particularly in reproducing bass tone), so hearing a variety of options and choosing the one that best suits your ear is recommended.

Another consideration is having two or more sets of monitors. Being able to A/B from a larger pair of speakers to a smaller pair, for instance, can help give you different perspectives and information on the same mix.

## HEADPHONES

Like monitors, quality and clarity are al-

most synonymous when considering headphones. An excellent set of headphones, from a recording engineer's perspective, is one that gives a truly clear representation of the recorded sounds without added color or filtering. Consumer-oriented headphones are designed to boost bass and highs and sweep out the mids, which is not what you want if you are relying on your headphones for an accurate mix.

For a mixing and recording engineer, a set of cans that are sealed and that have a flat response are necessary. You can find headphones marketed as "flat response" or "reference" starting at \$50, but to step up to mixing quality phones, you'll find the entry level is probably more like \$150. You can spend plenty more than that, and a high-end headphone can cost upwards to \$500.

Of course, you'll need more than one pair of headphones, and what is true for the mixing engineer is not true for the recording/performing artist. Quality phones that cut out external noise will always be valued, but for playback and performance purposes, the artist can get by with something substantially less than reference headphones.

Here, though, is also where durability should be considered. You'll be sure to take good care of a pair of headphones you dropped \$200 or more on, but the cans the artists are using will get significantly more abuse. Cheap cables can cut out, headphones get dropped or pulled off a player's head by accident, and whipping headphones on and off during a session takes its toll.

One last thing to consider for headphones is extension cables. Being able to feed a long enough line to someone recording a part will require more line than your headphones will provide, so plan on one extension cable per headphone—they start around \$10 per cable.

#### Headphone amp

You're going to need to feed a headphone mix to various musicians simultaneously if you're tracking more than one player at a time, and you'll need to boost the sig-

nal fairly significantly if you're recording an amplified guitarist or drummer. There is a huge variety of headphone amps and mixers on the market, and the price range depends on the number of inputs, functionality, degree of control, and the amount of power you want.

A really basic 4-channel headphone amp/mixer with individual volume controls can be found for under \$25, but chances are, if you need any degree of sophistication, you might be in the market for a rack mount unit, which start at \$150.

#### ACCESSORIES AND EXTRAS

Your accessories list can be extremely long, depending on your environment and preferences, but if you're working with a computer, consider a fader port—starting around \$100, you can use faders and pan knobs from a USB fader port and use your hands to control your software rather than a mouse and keyboard.

And like cables, microphone stands and accessories are an expense you might overlook when budgeting for your studio. Boom stands can run around \$30 each, and mounting clips for drums, gooseneck adapters, and a pop filter for vocal recording are items you'll want to have on hand.

**Music stands and guitar stands** are also handy to provide your performing musicians and can run from \$10-40 each.

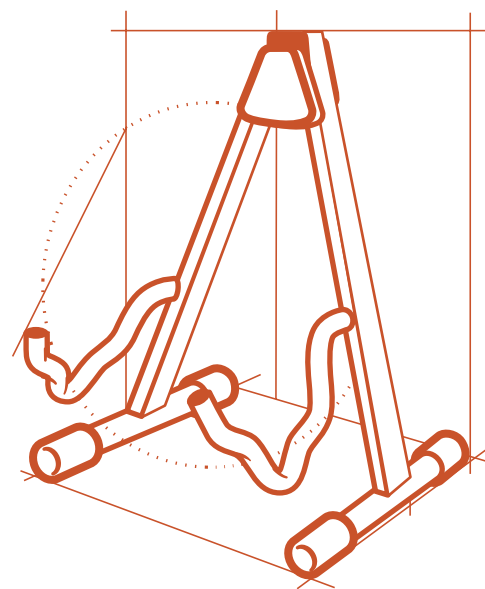



# HOW TO RECORD IN YOUR HOME STUDIO

## TIPS FOR RECORDING GUITARS, BRASS, PIANO, DRUMS, & VOCALS

### ACOUSTIC GUITAR

As with every acoustic instrument you record with a microphone, the major factors in capturing a great tone from an acoustic guitar include the quality of the player, the quality of the guitar, the type (and quality) of the microphones, your choice of mic placement, and the tonality of the room.

If you have a beautiful sounding guitar, most any microphone can do the trick, though a small diaphragm condenser is probably the mic of choice in this situation, as it will pick up the **transients** of the plucked string.

Experimenting to find the “sweet spot” of the instrument is worth the effort and can be achieved by plugging one ear and using the other as a “mic,” moving around until you find the spot where the tone sounds best. Some ideas for a starting point with mic placement for an acoustic include one foot from the instrument, with the mic pointing at the spot where the neck meets the body; two feet away, with the mic pointing at the bridge; 18-24 inches away, pointed at the 12th fret. Ultimately, the tone you’re looking for, the amount of pick and string sound, and the amount of fret noise you want will factor into the best spot for your recording.

If you want to add additional mics, listen for the different qualities in the sound of the room as the player is performing and determine if things are sounding good. If they are, use a mic to capture that quality, using your ears to identify the best spot in the room to place it.

Another option, if you are using an acoustic guitar with a pickup, is to send the pickup signal to another track. Pickups can often deliver a more focused bass response, so you can boost the guitar’s low end to complement the mic’s mid and upper frequencies. A final approach is to amplify an acoustic guitar through a cabinet for a more compressed, focused sound. Rather than plugging straight into an amp’s input, try going to an external mic preamp, and then into the effect return of the guitar amp to bypass the amp’s preamp.

“And no matter what,” exclaims Raison, “*change your strings before you record!*” And if you’re smart, you’ll also hand off your guitar to a guitar tech who can check the intonation. Spend the \$50 to have your local music store set the thing up. It’s the best investment.”

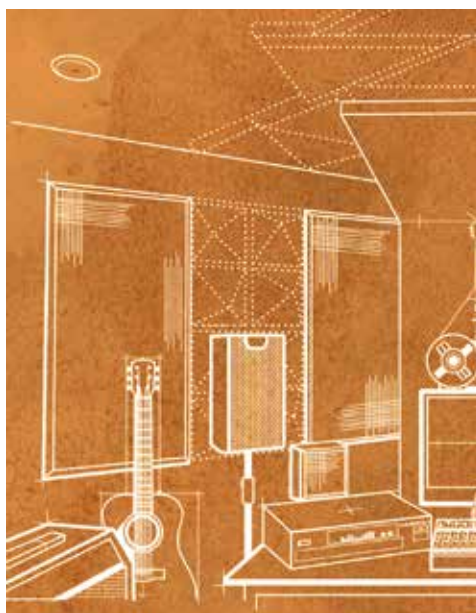

### ELECTRIC GUITAR

Before recording an electric guitar, you first have to get a tone in the studio that everyone can live with. We’ll assume that you’re not going direct to tape (or disk), though that is a viable option. Amp emulators are very useful and sometimes necessary in a home studio environment, but we’ll address the prospect of recording a live amp in the studio.

A guitarist’s go-to sound will often include a maxed out amp at serious volume levels, but that might not be a possibility for the studio environment, which means you need to be able to get a tone both the guitar player and the engineer can love at a workable volume. Take the extra time to do some **source monitoring**—listening back to the recorded tone to make sure what you have on record matches everyone’s expectations.

Miking a guitar amp is simple enough, though there are many variations to consider. Finding the sweet spot, just as you would for an acoustic instrument, requires varying your distance and spot relative to the speaker. Don’t point the microphone directly at the cone; you need it at a slight angle to aim it at the sound source. From there it’s about slight adjustments to the angle, placement, and distance.

When it comes to mic choice, dynamic mics are the overwhelming recommendation, mostly as the tone of an electric guitar, across any genre or style of play, comes down to the mids.

“The reason why guitarists predominantly use 12-inch speakers,” says Raison, “comes down to balance. A 12-inch speaker does not have lots of highs or lows. It’s the middle, the crunch, the bite. That’s why I tend to use dynamic mics on amps. If you use an expensive large or small diaphragm condenser that has lots of high and low-end extension, you’re collecting sound that’s not going to benefit you, but that you’ll have to deal with when you mix.

“A dynamic microphone close up on the paper cone gets me the results I want. If I want to add a second mic, I’ll put it elsewhere in the room, sometimes faced away from the cab. That allows me to pick up the **ambient** tonality of the amplifier driving the acoustics of the room.”

### BASS GUITAR

When you’re recording an electric bass guitar, blending a direct injection (DI) line recording with a miked cabinet is the safest way to make sure you’re going to get the tone you’re looking for. Somewhere in the blend of those tracks, you’ll find the tone you need for each song.

“The style of music can certainly dictate the kinds of mics you’re going to choose,” says Weiss, “and how far the mic’s going to be away from the cabinet. But, it’s always safe to have the DI. There’s more unaltered information coming from the DI, and you’re getting the fastest **transients** you can imagine. I tend to concentrate on the attack of the bass sound with the DI, and the roundness and the body of the bass I pull out of the microphone. The miked amp can give you a lot of that middle- and low-end tone that you’re not going to get out of a DI.”

As with guitar, the majority of the mics used on a bass or guitar cabinet are dynamic mics. There are some situations where you might put a condenser mic on a bass cabinet—the Beatles, for instance, often used a Telefunken U47 condenser on the cabinet. But more common will be something like the AKG D12, which features a large diaphragm designed to pick up bass frequencies.

“For a punchier tone, get closer to the amp with your mic,” says Weiss. “For jazz, I might go with a mic six inches off the cone. If you’re trying to get that low frequency of the bass, you might want to pull that mic back a few feet. In order to hear a low E on the bass correctly, you need to be about 30 feet away.”

### PIANO

Pianos are incredibly dynamic instruments. They’re very percussive, and they resonate a lot, so a lot of microphones can get overdriven with a live piano. Also, weather conditions can really affect a piano. When humidity is high, the piano is probably going to sway off of A440 Hz and might have a darker tone, which can affect the sound of a recorded piano from week to week.

With a grand piano, having the top open or closed will also make a big difference in tone. When the lid is up, the sound reflects off the bottom of the lid and is directed outward, and there will be more articulation. When the top is down, in most cases, there will be a reflection and resonance from the bottom of the piano.

Microphone placement options vary for a piano—you could potentially use up to five microphones to record a single performance. You can start with a small condenser microphone pair in an XY pattern—or three condensers split between the high, low, and middle keys. If a mic is placed close to the strings you can record a more percussive sound—if you’re further away, it’s going to be rounder. Placing a tube mic next to the player’s head to get the perspective of the player is also an option, in addition to mics placed in strategic points of the room to collect the **ambients**.

“How important the track is to the song is a big influencer in how I’ll record it,” says Weiss. “If it’s a solo piano piece, and I want the biggest, most beautiful piano sound ever, I’ll place more mics in the room to collect a variety of sounds.”

When recording an upright piano, you won’t be able to get a microphone close to the strings like you can with the baby

grand, so you can mic it from above, you can mic it from the perspective of the player, or you can mic it from the back. Of course, you can use multiple mics and then decide at the board how they should be combined.

Piano plug-ins are a serious consideration for anyone recording piano, in a pro or home studio. Beware, warns Raison, “Piano plug-ins sound spectacular, but they sound so spectacular that sometimes I don’t believe them. If you’re recording an acoustic guitar and piano at home, and the acoustic sounds like a human playing in your room, and the piano sounds like a Bosendorfer at The Met, it sounds too good. So even if you mic an upright with a single dynamic microphone, it will sometimes sound more down-to-earth and real, and that has a lot to do with it.”

### REED AND BRASS INSTRUMENTS

In a recording situation involving brass and reed instruments, you should probably use more than one mic, as there’s typically a lot of movement and activity. A professional player who is used to a studio setting might be able to stay still and work the mic, but a good approach to get consistent dynamics and a full tone is to use multiple mics to balance the sound as the player moves around.

The most common approach is to start with a large diaphragm condenser mic about 10-15 inches in front of the bell. If that sounds too harsh, pull it out a little farther. Don’t point the mic directly into the bell, as you might get some wind noise or odd reflectivity back into the mic. Positioning the mic at different angles, starting at 45 degrees, can help remove the unwanted artifacts.

If your microphone has switchable pickup patterns, set it to a cardioid pattern to begin. You wouldn’t want a hyper-cardioid pattern due to the movement and activity. Set it somewhere between cardioid and omni if your mic has a variable pattern selector. In some cases, if the room sounds great, you might consider putting the mic in omni—you’ll get more of the room sound, which may work for your recording.

The tighter the pickup pattern, the more directional the mic will be, and the more focused the sound.

If available, a creative approach for a second mic is to put a ribbon microphone above the player, three to four feet above the instrument. One quality of a ribbon mic—and a reason they were the go-to when recording horns—is a ribbon mic has a way of removing any of the harsh tonal qualities from brass and reed instruments.

If you're in a situation where you only have one mic, move it around the room until you find the sweet spot where you're getting the best available tone.

"In some cases," says Weiss, "you might not be searching for that perfect tone. You already have your mix, you're recording a sax solo, and you need it to rip through the mix, so you already know what instruments you need this to sit on top of. Move the mic around the horn to find that sound you need to get the right presence from the sax."

If you're in a room that's small or doesn't have great acoustic control, you'll probably get a lot of resonant frequencies from a horn or reed instrument. Using some type of **baffle** in the room or around the mic is one approach to keep the energy concentrated and dampened around the mic.

Another tool to aid in recording sax is to use an audio **compressor**. A saxophone tends to be very dynamic, so the same approach you might use on vocals also works great for smoothing out the dynamics of sax.

"With a sax, there's a distinct bite at the beginning of the sound," says Weiss. "If you're using a compressor, and you're finding that the top of the note is being lost in the mix, you can pull the attack time up a little bit so that you get that bite out of the sax before the threshold is reached. So much depends on the performer, the room, and the plans for the track in the recording."

## VOCAL

For any recording project that includes a

vocal, capturing the ultimate performance might require some push and pull between the producer and the talent, and often the tact and technique of the producer plays a pivotal role in the quality of the recorded performance. The producer's experience plays a big part in this.

"I usually go in, put the mic up, and let the vocalist run through the track a few times," advises Weiss. "I'll let them roll for a little bit, and I'll tell them I'm not even listening, I've got the monitors down, but once in a while I'll listen in to see where they are. There's a standard that every producer is looking for from a vocal take. The type of song has a lot to do with how much emotion you want to pull out of the artists. You've got to feel the artist out."

It starts with creating a relaxed environment for the vocalist, which could mean getting as many people out of the control/recording room as possible. The vocalist is often going to be more comfortable if it's just the engineer getting the sounds to tape and maybe a producer or one other band mate there to monitor the session.

Another must is getting a really good mix for the vocalist in the headphones. While a lot of engineers won't put delay or reverb on a track until they mix, with singers, you might want to pick out a reverb and put that on the track in their cans. Work with the vocalist and make sure he or she is happy with what they're hearing in their ears before you start the recording process.

Another trick to getting a great vocal track is to record and keep multiple tracks. What sounds good at the end of the night might not sound as good the next day. A rule of thumb is to have three full tracks recorded, and from there you can build a **comp track**—or a finished track that's a combination of the best lines from the three.

Of course, another thing that's really important is getting the right mic for the right voice. Traditionally, this is where a pro studio will have a leg up on a home studio, in owning a variety of high-end vocal mics to choose from. For the home enthusiast, rent-

ing a pro mic is an option, though you need to know which mic you want to rent. But investing in one or two quality microphones for vocals is ultimately a good investment, as well as having quality **preamps** to match.

And there are other simple tips that will make a big difference when embarking on the vocal take in your home studio. "A gigantic red flag for me," says Raison, "is when I hear a recording done without a pop filter. The air motion from the p's and b's, when they hit the diaphragm, will cause it to break up, and it's the worst sound you can get on a vocal. I'm not suggesting you use a slide on, foam windscreen. We're talking about a four- or five-inch disk that has thin, acoustically transparent, nylon. When the plosives come out of your mouth, that stops the air velocity from hitting the diaphragm. It's a \$20 solution to a better sounding recording.

"Another trick is to try different distances to the microphone. Four inches can make a substantial difference in the tonality of one's voice. You need to be cognizant of the amount of **ambience** being recorded on a vocal. One tip I give people in home recording situations is to build a vocal booth out of quilts. In a home studio I had, I would hang up quilts in the laundry room, just to knock out the ambients. Or stick the microphone in a closet between a bunch of coats and sing into the coats. Coats are fabric, they absorb."

## DRUM KIT

Recording a full drum kit in a home studio poses numerous challenges. Employing multiple mics requires owning numerous microphones, stands, and cables—not to mention utilizing the proper placement and techniques to avoid phase problems, room anomalies, and acoustic issues. Recording stellar drum kit tracks requires skill, patience, and the right room.

But that doesn't mean you can't record drums at home. One consideration is to use fewer microphones. Sometimes just a kick microphone, and a stereo pair—either overhead, in front of, or behind the drummer—can provide functional tonality and

stereo image. Adding another mic for the snare is also an option, and taking the time to be creative with your mic placement and **source monitoring** to ensure you are capturing a well-balanced mix is key.

Tuning the drums before a session is also of huge importance. “I sometimes work with drummers for hours to get their drums tuned to where I think they’re going to reproduce correctly to tape,” says Weiss. “It’s not uncommon for a drummer to have their kit tuned to where they practice and gig with it, and it sounds great. Then you put a mic on the tom in a studio setting and it’s ringing like mad. Getting the drums ready for recording is an important step.”

Another consideration, not specific to tone, but rather to performance, is to use a *click track*. If it’s a jazz track, or something more organic that needs room to ebb and flow with regard to tempo, you can forego this, but a click track not only promotes a solid tempo for the entire song, it enables you to edit and add to the track after the tracks have been recorded. The potential for rearranging parts, swapping sections, adding rhythmic elements, altering arrangements—for the drums tracks and any other—is made possible with the use of a click track.

#### KICK DRUM

Start by listening to the drum with no muffling. Ideally, the drummer has a hole in the front head (or has removed it) to facilitate the removing and adding of muffling material. Make sure the beater head is evenly tuned before adding muffling. Thin sandbags work very well as a muffling agent in a kick drum, and pillows, sweatshirts, foam, and blankets can also be used, though be

aware that these materials can absorb some of the high-frequency energy of the drums’ tone.

Mic techniques can run a gamut of possibilities, but placing one microphone inside the middle of the drum, pointed at the beater at a 45-degree angle, is a typical place to start. For a more “tappy” sound, push the mic closer to the head. Using a disc (Remo makes the “Falam Slam”) or even taping a coin to the beater side of the drum will increase that slapping sound of the beater striking the drum.

Adding a second mic, placed a foot or more in front of the front head, is an option, as is isolating that mic with a heavy blanket or pad.

“I’ll make a teepee,” says Weiss. “I’ll take a boom mic stand at a 90-degree angle, and place the arm of the boom on top of the kick drum—making sure there’s foam or something between the stand and the drum so I don’t scratch the drum. Then I take a heavy blanket, like a moving blanket, and make a tent out of it. At the end of the tent, I put a shotgun microphone, and that’s where I get the extended low end. You can use any mic, but I prefer the sound of the shotgun. If you have the mics and the inclination, you can even add an additional mic on the beater side of the drum.”

#### SNARE DRUM

The ideal snare sound for any given recording is going to depend largely on the style of music, type of drum, tuning, and preference of the player. But in general, it’s the combination of the top drum head and the rattling snares that you’re trying to capture. The snare sound is also going to be judged

against the sound of the kick. In a standard 4/4 set up, the snare is the answer to the kick drum, and the snare and kick have to work together to pull the song forward.

Depending on your degree of patience and expertise, using anywhere from one to three mics on a snare can do the trick. Aim a unidirectional dynamic mic, coming in from the hi-hat side, at the spot where the drummer is hitting the drum. Angling the mic toward the rim will change the tone, and give you more of a ringing sound.



On the bottom head, to capture the rattle of the snare, position a large diaphragm condenser, starting at a 45° angle to the head. Avoid placing this mic parallel to the head, or you could blow out your mic. A third mic that can add a chunky body to your snare sound is a small-diaphragm condenser placed a half-inch off the side of the drum, pointed directly at the middle of the drum between the rims. Combining these two or three mics can give you a variety of sounds to blend for different tones on different tracks.

#### TOMS

A condenser or dynamic mic of choice on the toms is standard, with the mic angled toward the spot the drum is being hit. As with the snare, angling the mic toward the rim will give more of a ringing tone to the drum. And damping the drum with tape or “O” rings is often necessary in the studio environment. Some ringing is usually sought after, but an abundance of it can be a problem.

#### OVERHEADS

Small diaphragm condensers placed in a stereo pair above the drums fill out a drum mix and provide the high-frequency energy from the cymbals and snare. Crossing the mics in an “XY” pattern above the center of the kit (anywhere from three to six feet above the kit) or placing one mic over the bell of the ride cymbal and the other above the hi-hat are two common approaches to these mics. As with anything, experimenting is key, as every drummer and every drum kit will produce different results in your room.

 Another consideration, not specific to tone, but rather to performance, is to use a click track. A click track not only promotes a solid tempo for the entire song, it enables you to edit and add to the track after the tracks have been recorded. 



# RECORDING LIVE MUSIC

## RECORD YOUR GIGS FOR RELEASE, REVIEW, AND PROMOTION

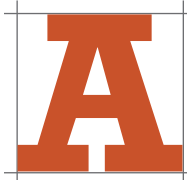

s with home studio equipment, affordable, high-tech recording equipment has made the prospect of producing a high-quality remote recording a reality for every independent musician.

Even in the early days of accessible recording technology—think the ADAT and early portable consoles—the prospect of recording a live show with any degree of control often required multiple recording units chained together, hundreds of feet of cable, a bulky mixing console, and more. This equipment, while a leap forward in portability and ease of use, still took up a lot of space, making transport and set-up in a remote location a challenge.

High-tech recording equipment is smaller, more powerful, and more portable than ever. Combined with the increased use of digital consoles in live music venues, opportunities to record remotely at a live venue or non-studio space are plentiful. It is theoretically possible to arrive at a gig with a thumb drive and leave with a pristine stereo recording of your performance. Note that last sentence says, “theoretically possible.” While technology has made it much easier to record remotely, there are many things you’ll need to do, and expertise you’ll need to rely on, if you’re looking to produce a quality live recording—particularly if you’re looking to record for release.

### IT STARTS WITH A FEW QUESTIONS

*What are your plans for this recording? Is this to be a CD release for sale online and at future shows? Are you giving the recording away to fans as they exit the performance? Are you going to make this available as a download after the show? Is this for pre-production purposes for an upcoming studio recording? Are you archiving your set to analyze your performance and critique internally? Your intentions for the final product will factor heavily into your equipment needs, choice of location, and the preparation required for your recording.*

*What is the arrangement of your act? Are you a solo acoustic guitarist with one instrument and one voice? A three-piece power trio? An eight-piece band with horns and back-up vocalists? The more complex the arrangement, the more sophisticated your needs will be in regard to equipment, set-up, and expertise.*

*What are your options for a venue? Are you playing in a coffee shop with your own PA? Are you the third of five bands on the bill? Are you headlining a show in a large room? Do you have access to multiple nights in the same venue? What kind of console does the venue have?*

The answers to these questions will lead to others, and this chapter will help you plot a course to produce the best live recording possible within your means.

### Snapshot recording

If you are looking for something very basic, something to use as a tool to analyze your material, performance, arrangements, or the general state of your live show—what Raison refers to as a “snapshot” recording—then a bare-bones recording with a portable device is an easy solution that could involve minimal interaction with the live sound engineer.

[Zoom](#), [TASCAM](#), [Olympus](#), and other manufacturers make extremely portable and affordable hand-held digital recorders with built-in microphones. You can simply put one on a tall mic stand, place it near the mixing console (where it usually sounds the best), and collect a functional stereo recording. Note the tall mic stand: the higher up you can get your recording device, the less chance you have of capturing the vocalizations of the drunk patron who thinks he knows your set. These are also excellent devices to record rehearsals or song ideas when developing material.

But these digital devices can do more than just record via their built-in microphones. With the cabling options provided, you can often plug into a venue’s console (with the cooperation of the live sound engineer), and get a stereo feed of the mix. With 4-channel versions of the stereo devices, you can get a stereo feed from the board and combine it



with room mics (provided by you), which offers more post-performance mixing options. In some cases, when you combine the direct mix from the front-of-house console with a pair of well-placed microphones, you can end up with a great sounding finished product.

And it's not just these portable recording devices that have gone digital: many live music venues are investing in digital consoles, and almost all of these have a jump drive (thumb drive, USB drive) or access port so you can plug in a USB thumb drive or a hard drive and capture whatever the mixing board is putting out as a stereo feed.

Will this board mix be good enough to release? Maybe. Many variables will determine whether such a recording will be suitable for distribution—including the complexity of your act and sound of the room—but with practice and a little luck, and particularly when you provide yourself some control over the mix after the show, your chances of coming away with a releasable recording improves. But these basic recording techniques are designed more for the snapshot recording concept—recording for a release is likely going to take a bit more work pre-show, during the show, and in the mixing process.

#### Hard-pan the stereo feed

There is a variation of the stereo board feed that can especially serve a solo singer-songwriter looking to release a recording of a live performance. If you can pan the mix hard right and hard left, with your instrument in one channel and voice in the other, you are essentially creating a multi-track recording that you'll have some control over after the show.

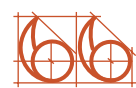

As you get deeper into the notion of a live recording, however involved the process, it may become clear that involving a professional, or at least someone who can act as your recording engineer, will be necessary to provide the results you want.



"If you're a singer/songwriter, and you're in a venue with a small digital console," says Raison, "you can ask the sound engineer to pan your acoustic guitar hard left and your voice to the right, and you essentially walk away with a multi-track recording. The instruments are discreet, so you have the ability to dump that stereo track into your editing system—which could be your DAW, or GarageBand, or even your phone. You can take that stereo file and split it to two mono files, and that gives you the guitar and the vocal discreet from each other. It's a simple way to leave with a multi-track recording that you have control over after the show.

"If you have a four-channel device and can add in additional room mics, you can blend them in and get a pretty fantastic final mix. You can record an entire set, and the next day you can dump it into your system, mix it, finish it, and use it as promotional material, release it online, or sell it. And if you do this at every single gig, you can amass a catalog of performances and let the good stuff rise to the top. Compile the best performances and recordings and you have an excellent live release on your hands that you can sell on CD or use to get more gigs."

#### Multi-track recording

As with a studio recording, the more control you have of the audio after the performance, the better the chances you'll be able to produce a release-quality live recording. That means getting individual tracks for the various instruments and vocalists, as well as some room mics to capture the sound of the room and the crowd.

Many digital consoles offer the opportunity to capture an individual, or discreet, feed of

each microphone to a separate track. Depending on how the sound engineer sets up the stage, this could make it possible for you to collect each microphone's signal—each individual instrument and vocalist on stage—separately, direct from the board.

Let's say there are four microphones on the drums, one channel for bass, another channel for guitar, and three channels for lead and background vocals. Many digital consoles are able to provide a send of each input—with each track isolated—so you can access each track individually. Not all digital consoles will have this capacity, some might require a special card to enable that functionality, but getting access to individual tracks is more commonplace than ever before. In addition, many analog boards will allow you to send individual signals, input by input (i.e. mic by mic) to an outside source, such as your recording device or DAW.

But even with this relatively easy access to the individual mic feeds, not every instrument on stage is being miked, particularly in smaller venues. The snare drum may be putting out plenty of sound without a mic, there may not be overheads on the kit, or maybe the bass or horns have no line to the board.

In a larger room, you are more likely to have everything miked, and therefore you'll be able to get more discreet signals. But in any live recording environment, getting all the signals, including direct outputs from the bass amp and adding mics to collect the sound of the room and crowd, can be a positive (and necessary) addition to your recording.

How you collect and store these signals is one of the many questions you'll need to address, and your solution will depend on the venue's soundboard, your system (if you're doing the recording), or your engineer's (if you're outsourcing). If you are going to do the mix in a home studio set-up and have a laptop or portable digital recording device, determining how you'll interface with the board will be part of your pre-show check-in with the house sound engineer.

## Mic splitters

A mic splitter is a tool that helps an engineer collect signals from the stage. The idea is basic: A mic cable runs from the on-stage microphone to a snake, and from that to the board. A mic splitter gets placed between the mic and the snake and sends one signal to the snake and the identical signal to another destination—in this case, your recording device.

As Raison explains: “I have three inexpensive mic splitters, each one is eight channels, and that allows me to get 24 channels to a digital recording system. These splitters were reasonably priced, maybe \$300 each. With advance discussion with the house sound engineer, they’ll often let us split the stage signals, which allows me to take a feed of every microphone running from the stage. Plus, we can add our own microphones if we need them.

“So if you want to make sure you’re picking up the tom-toms discreetly, you can put your own mics on there. If the sound person doesn’t use overheads—in a small room, cymbals can be really really loud so they may not feel the need to put a microphone over the cymbals or over the drum kit—but with a recording, it’s a requirement. So you can throw a mic or a pair of mics overhead. A room microphone or two also really helps shape the sound. Especially in a large venue with an excited audience.”

Of course, you’ll need to run cables for every mic, have stands for every additional microphone you’re providing, and have a way to plug all these inputs into an interface for your laptop/DAW or have an all-in-one recording device on hand, which will add to your expense, equipment needs, and set-up time before the show. Understand that you may need to collect dozens of signals via microphone/instrument cable, which means you’ll need to have the means to have inputs and storage for all these signals.

## Meeting with the live sound engineer

Any time you are recording, and particularly if you are expecting assistance or the involvement of the live sound engineer, it is imperative that you meet with him or her before the performance.

“Typically, when you’re advancing a live show,” says Barbara Adams, Philadelphia-based live sound engineer and music technology professor, “you should be doing that two weeks out, just to touch base with the venue and say, ‘This is what I’m coming in with, this is the set up of my band.’ Usually, you’ll send an input list or a stage plot and that’ll give us an idea of what we’re working with.

“If you’re planning to record, when you’re advancing the show, say, ‘Listen, we’re going to try and do a live recording.’ You want to give the house engineer as much advance notice as you can. If a band contacts me and says they’re going to do a live recording, I’ll give them the options and say we can give them a straight board mix right from the desk, or if they want to get the individual outputs, these are the outputs of my console, you’ll need to bring in these specific cables. I’ll do my part to make sure they’re prepared, and let them know what they need to bring. So the more advance notice you have, the better off you’ll be the day of show. Showing up the day of the show without any notice, if you plan on doing a recording, can be pretty rude, and it will not get you the results you want.”

“Having the necessary cabling to interface with the soundboard is critical,” confirms Raison, “whether it’s digital or analog. And that’s all based on an advance meeting with the sound engineer. What kind of mixing board do you have? What’s the best way for me to interface?

“And then there’s the issue of the room itself. Most soundboard mixing sites tend to be teeny tiny, and there’s not a lot of space to lay your stuff out. So if you have a laptop and a mic splitter and a this and a that, you’ve got to have a place to put it.”

Understanding the details of the live sound



**Don’t agree to something that’s going to change your environment in a disruptive way, and don’t decide to change up your arrangements or throw last-minute ideas into the performance when you’re looking to record.**



set-up and the layout of the venue—including what electrical outputs are available to you for your recording gear—is an integral part of determining what room you want to record in. What kind of board do they have? What will you need to provide to enable you to get the recording you’re looking for? What will and won’t be miked? What kind of cables will you need? Are you grabbing everything from the board? Will you need a splitter? How early will the club allow you to arrive in advance of your show to set up?

As you get deeper into the notion of a live recording, however involved the process, it may become clear that involving a professional, or at least someone who can act as your recording engineer, will be necessary to provide the results you want.

As Raison puts it: “You have to have someone to do the recording, whether it’s the soundboard operator or somebody that you bring with you. If it’s the soundboard operator, you need to have that conversation up front. They need to make certain the outputs of the mixing board are not clipping the recording system, because if you record distortion, distortion is on it for the rest of its existence. Whoever is managing your recording needs to know something about keeping the signal clean and not distorted.”

Make no mistake, the sound engineer’s job is to get the room mix right, and those requirements may be quite different than what you need for your recording. Getting clean strong signals to your recording device, and not having them clip, is of the utmost importance.

It goes back to the fact that having access to the equipment and knowing how to use it effectively are two different things—and experience is a huge factor. Bottom line, if you plan on doing a recording on your own, whatever the intention of the final product, don’t

expect to deliver outstanding results the first time you try. It may take five or six attempts before you achieve a recording that matches your expectations.

### Performance anxiety

Of course, a pristine recording of a terrible performance is no better to you than a botched recording of your best night ever. Whatever you can do to promote comfortable conditions for the performers, the better.

In practical terms, this could mean making sure mic placements aren't throwing off the drummer or additional mics on stage aren't getting in the way. Don't agree to something that's going to change your environment in a disruptive way, and don't decide to change up your arrangements or throw last-minute ideas into the performance when you're looking to record.

You are much better off playing to everyone's comfort levels if you expect to record your show. Of course, if you're experimenting with a new percussion part or adding another instrument into the mix and you want to hear what it actually sounds like in a performance

setting, that's an ideal time for a snapshot recording. But if you're looking to record a show for a release, that's probably not the time to introduce a new performer, string section, backing track, or major new element to your set.

And be especially particular when it comes to tuning your instruments. Obviously, tuning your instruments is a prerequisite for every show, but you must be sure every guitar, bass, violin, piano, etc. is carefully tuned prior to the gig when you're recording. In fact, stringed instruments should be checked and tuned as necessary, even between songs, and drummers should do their best to make sure the drums are all tuned and sound good acoustically before the set begins.

### Recording for release

Ultimately, as an artist looking to release a live recording, you need to be flexible, because once you get all the prep work done, you've chosen your venue and got all the equipment set, the band might end up having a terrible night. That's the nature of a live recording.

"If you're doing a recording because you

want to release it," Raison advises, "try to do a series of recordings, not just one. If you do it all on one night, as my mom used to say, you're carrying all your eggs in one basket. You drop that basket and all your eggs break. So when we did larger concerts at Philly Sound Studios, we'd recommend that we do two or three nights in a row, not because we're expecting technical problems, but sometimes it just doesn't work creatively on stage."

This could mean multiple recordings at the same venue or various recordings from multiple venues. The idea is to lower your risk and increase the odds of capturing a great performance. The more you do it, the more likely you're going to get it right. Plus, multiple shows take some pressure off the players to have only one shot to dial in a stellar performance.

Hiring a professional is another way of taking some pressure off the performers. If you are an artist or band member recording a live album, hiring an experienced sound engineer can help you and your bandmates focus purely on delivering a concert you'll be proud to listen back to for years to come.

**ORDER YOUR CUSTOM-PRINTED USB DRIVES**

These customized USB drives can hold your recordings, photos, and videos — and they fit in your pocket! USB drives are a great addition to your merch table and could be just what your fans are looking for.

- Assembled, printed, and packaged in the USA
- Available in various sizes, shapes, and designs
- 48-hour Priority turnaround available
- Free next day shipping on all styles
- Your satisfaction is guaranteed

**ORDER TODAY!**

**DISC MAKERS®**

Call 800-468-9353 or visit [www.discmakers.com/usb](http://www.discmakers.com/usb)

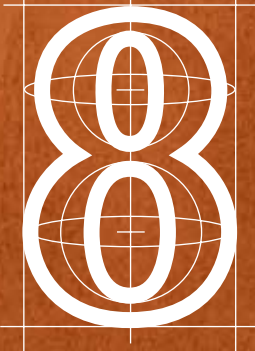

# USING PROCESSORS & EFFECTS

## HOW COMPRESSORS, GATES, REVERB, DELAY (& MORE) CAN HELP YOUR RECORDINGS

**I**n addition to your microphones, DAW/console, and room, an essential part of any home studio set-up is your signal processing gear. From the dynamics control of compressors, limiters, and gates to the effects processing of reverb and delay, these tools are integral to producing a professional-sounding product.

For an inexperienced engineer, the precise functions of these effects can be somewhat mysterious, and the overuse of plug-ins and outboard gear is commonplace. Understanding how processors like compressors and limiters function and knowing how and when to use effects such as delays and reverbs will make you a better producer and help to enhance the sound quality of your recordings.

### DYNAMICS CONTROL

#### Compressor

In audio recording, a compressor reduces the amount of output signal level in relation to the input signal level, according to a given ratio, beginning at your user-defined threshold. In other words, it brings the loudest sounds down and brings the softest sounds up.

“How much a compressor will affect the dynamics of a track is ultimately determined by the ratio setting. First, you set a threshold for the input signal, then you set your ratio. A compression ratio of 2:1 means that for every 2 dB the sound level comes in above your set threshold, the output level is reduced by 1 dB. So if the input level is coming in at 8 dB above the threshold, the output is reduced to 4 dB above. A ratio of 4:1 increases the attenuation: at 4:1, the signal coming in at 8 dB above the threshold has an output of 2 dB above. It’s as if you were riding the gain on a console fader; when the input signal gets too loud, you pull the fader down, lowering the gain.”

Compressors are typically used on any performance that includes a wide range of dy-

namics. Let’s assume you’re recording a song where the vocals have verses that are dynamically consistent, and at a moderate volume, but in spots, the vocal level drops to an intimate, whispery style and the signal is getting lost in the mix. Here is a situation where compression will do the trick.

Depending on how great of a dB variation, start by setting the ratio to approximately half the difference between the highest and lowest vocal level on the track. For example, if there is a 10 dB difference between the vocal’s dynamic high and low point, you can set the compressor’s ratio to 5:1. Now reduce the threshold setting to the point at which you want the gain reduction of the vocal to start.

Once applied, you may find that the overall vocal level has been reduced considerably after being processed by the compressor. It is often necessary to raise the output gain of the compressor to bring the vocal back to a usable listening level.

When first applying your compression, you may actually notice the sound of the gain reduction being applied, which makes the performance sound unnatural. This can be addressed by adjusting the attack and release parameters. Attack is how quickly the detector circuit picks up and affects an input signal that exceeds the threshold. Release is how long the compressor stays in effect after it’s been triggered.

Let’s say you want the bass track to sound punchier—you want to make sure the attack of the beginning of every note gets articulated clearly. You can set it up so that the attack time is 10 milliseconds, so the attack at the beginning of the note doesn’t get compressed, but the body of the note does. You’re telling the detector circuit not to kick in right away, but to kick in after 10 milliseconds.



Another setting on some compressors is the “mix” button, which determines how much of the unprocessed signal comes through in the output. You can have it on full, which means you’re hearing nothing but the compressed signal, or mix it in so that there’s a blend of compressed and uncompressed signal.

“The harder you hit a compressor’s detector circuit, the more you’ll hear it,” warns Weiss. “Ultimately, you want to control the dynamics but you don’t want to hear what the processor is doing. It can severely change the sound of the instrument if it’s overused. At the same time, it’s absolutely critical in recording. I’ve never heard a source—vocals, guitar, bass—that didn’t need compression of some kind.”

### Limiters

A limiter is basically a compressor, but where compressors have a variable output level, limiters have a fixed output level. A limiter allows you to set a maximum output level that will not be exceeded, regardless of the amount of input signal level. So while it can be described as a 60:1 ratio, or ∞:1 ratio, anything that exceeds your defined threshold is brought down to the output level you’ve defined.

Let’s say in your latest recording project there are phrases where the singer screams and growls at a much louder volume and with much more dynamic range than the verses. This is where you might choose a limiter.

First, if the verses and the screaming phrases are on the same track, it’s a good idea to separate the sections by copying the screaming and growling vocals to a new track. Let’s say the screaming is consistently much louder than the growl, and the growl is near the level you want the verse vocal to be. Apply the compressor on the new track and set the limiter’s ratio to the maximum value. Now adjust the threshold to a point at which both the scream and growl vocals produce the same output signal level. With a limiter, you can easily knock down the louder scream so it’s equal to the growl’s volume.

### Expander

An expander is the opposite of a compressor. Where compression takes a given dynamic change and reduces it, an expander increas-

es it, so louder sounds get louder and softer sounds get softer. There’s a threshold, an attack, release, ratio—the same controls you’ll find on a compressor. In fact, some compressors can function as an expander. So when a signal comes in that is below the threshold, an expander boosts it to be above it.

“An expander could be used with percussion,” says Weiss, “if you really want to accent the harder strokes, or maybe on bells that have sort of flatlined and you need them to be more expressive. And on some occasions, expanders can undo compression mistakes. If you’ve over compressed something, sometimes, if you’re lucky, an expander can bring back some of that dynamic range.”

### Noise gate

Noise gates function by setting a threshold level that determines the amount of input signal required to open the gate, then only letting the selected audio pass through to the gate’s output. Any sound that comes in below the threshold value will not open the gate—in other words, they will effectively be removed from the track.

Like compressors and limiters, the noise gate has a user-definable threshold, provides variable gain reduction, and offers attack, hold, and release time parameters. Some gates also have selectable frequency ranges where you can focus on everything from 1k down (for example), or 1k up, or a custom range of frequencies. This function makes the unit a lot more accurate.

Let’s say you’ve got a floor tom track in which the drum was close-miked, and listening back critically, the five-second decay blurs the tom’s definition. You can live with some of the ringing tones, but you want to clearly hear the attack of each hit on the floor tom. This is a situation where a noise gate can be very effective.

Loop the phrase so it plays continuously, then insert the noise gate on the floor tom track and set the threshold level to the point at which the hit on the tom just barely opens the gate. Now adjust the attack, hold, and release parameters to achieve the desired effect, reducing the long decay.

Noise gates are very useful when you need to eliminate any unwanted incidental sounds that may have been recorded. For instance, use one on vocals to eliminate breathing sounds between lyrical phrases, or on a distorted lead guitar to eliminate overdrive noise between lead passages. Noise gates can even be used on the stereo mix bus output to really tighten the breaks in the song.

Noise gates can also create problems, since everything recorded on the track you are gating is eliminated according to the gate’s envelope, including any ambient leakage. This can sometimes cause a perceptible and distracting dropout on a given track. To address this, many gates have a balance or mix parameter, which allows you to choose how much of the original signal and how much of the gated signal is heard.

With a drum kit, for instance, there’s typically so much noise in the room, and all of that combined noise is contributing to make up the overall sound of the drums. While you might want to gate the snare and kick, you don’t want to do a hard gate and lose all the ambient noise. Using a blend of the gated and direct source allows you to balance the two so you lose the distracting noise without compromising the overall sound of the drums.

### EQ

An equalizer, or EQ, is a frequency-specific amplifier that comes in two basic flavors: graphic and parametric. Both essentially make tonal adjustments by increasing or decreasing a frequency’s **amplitude**, but in the case of the graphic EQ, the bands are set at fixed center frequencies across the 20-20 kHz bandwidth. The number of bands may vary from 5 to 30.

A parametric equalizer is more complex, and controls more parameters of the sound and can control the level, the primary frequency, and the range of each frequency.

To better explain the use of EQ, let’s use a drum track as an example. During recording, it’s often difficult to distinguish between the direct sound of the drums in the room and what was being recorded. Now at mix, you’re hearing things you didn’t notice during the

tracking session, including the fact that the kick drum sounds a bit “tubby.”

After placing a limiter on the kick to even out the level, you found the overall kick drum timbre did not cut through. The large diaphragm dynamic mic you placed on the kick delivered a deep fat bottom, but the mid-range frequencies are overemphasized and the top-end frequencies are weak. To make adjustments relating to frequency, the EQ is the right tool.

To fine tune the kick drum, a 7-band parametric EQ might do the trick. In the case of the kick drum, the low-mid to mid-range frequencies—500 Hz to 2.5 kHz—might be the culprit causing the “tubby” kick sound. Tune the EQ’s frequency band to emphasize the tubbiness in both amplitude and bandwidth. Don’t be afraid to be extreme with the frequency’s amplitude control, you want to really hear the influence of the EQ on the kick drum’s sound. Once you have found the frequency at which the tubby sound is most extreme, drag the frequency point into negative values. This should greatly reduce the proper frequency range to minimize the kick’s unwanted tone.

The technique of emphasizing and then subtracting unwanted frequencies is one way to eliminate annoying hums, rings, and any other frequency zones that need to be equalized. This technique will also be very effective on a ringing snare drum overtone.

Finally, to give the kick drum a bit more definition, you can use the same method of experimenting to find the right frequency to boost and emphasize the kick drum’s attack. By boosting the EQ to brighten the transient attacks, the kick sounds fat, but now has the attack to punch through the mix without overpowering the other tracks.

## EFFECTS PROCESSOR

### Reverb

Both reverb and delay are time and space-related, and they are most easily differentiated by the discrete time that elapses between the original sound and its delayed reflection. Reverb is one of the oldest and most widely-used time-based effects. It can add

lush ambient room sound to any instrument. Like delays, reverbs generate multiple wave fronts, but there are a large number of fronts and the time differential between each front is extremely short.

It’s easiest to think of these fronts as reflections of the original sound, like the way an instrument sounds when played in a concert hall. The sound generated by the instrument moves out in all directions. It comes directly toward the listener but it also hits the floor, walls, and ceiling. The sound reflections from these surfaces return back slightly delayed from the original sound, depending on the size and depth of the space, and where the listener is in relation to the direct sound. Of course, the reflections off the floor, walls, and ceiling also continue to bounce off of the surfaces in the space and listeners perceive all those reflections at slightly different times, creating the perception of a spacious concert hall.

“Back in the days in Sun Studios, when Elvis was recording,” explains Weiss, “they’d have a tiled room with a speaker on one side and a microphone in the other. Using an effects send, they’d send his vocal track through this effects channel, and re-record the performance from across the tiled room and achieve reverb.”

“The next generation of reverb units were plate and spring reverbs. They’d send the signal through a long spring, or a series of them, and they’d produce reverb. Or there was a plate, literally a thin plate of sheet metal inside of a box, with pickups on it, and you’d adjust the reverb time by how much you were dampening the plate with a piece of felt. Even now, I don’t think digital processors can really replicate the sound of that plate reverb.”

Today’s reverbs emulate a wide variety of acoustical spaces. Some of the more common environments include a concert hall, room, church, arena, club, and stage. Some reverb plug-ins offer additional emulations taken from the analog reverb days such as plate, spring, and chamber. In all cases, there are a few common parameters that can be selected and adjusted.

Reverb type refers to the room being emulated (hall, room, etc.). Reverb size refers to how large of a space you can create. Diffusion is a parameter that determines how far apart each reflection spreads out from the instrument, giving a sense of depth. Decay adjusts how fast the reflections die out after the initial attack of the sound. Pre-delay is the parameter that determines the time differential between the direct sound and the point at which listeners perceive the reverb reflections. Finally, most reverbs have low and high cut filters that can reduce or increase harmonic partials as a part of the reverb’s reflections. These filters are very useful to create transparency within the reverb process.

### Delay

A delay is a time-based processor that generates discrete wave fronts of the input signal according to the delay time. Delay settings of 250 to 500 ms will create rhythmic interest while smaller times such as 20 to 80 ms can create a sense of depth. You can also create echo effects by increasing the amount of feedback, a parameter that returns the output of the delay circuit back into itself.

Many delays provide rhythmic note values, such as whole, half, quarter, eighths, etc., and offer a sync option that times the delay precisely to the tempo of the original track. A tap delay lets you tap a sensor pad in time to the music to set your precise delay time. The delay also has **low and high-cut filter** parameters, so you can change the frequency content of the delay generation when feedback is used. You can also modulate the delay time using the depth and rate parameters, and create variable moving rhythmic echoes.

One simple way to describe a delay is as an echo. Go into a large rectangular room (gym, garage, church hall, apartment building foyer) and clap your hands loudly and listen to see if there is a discrete echo. The smaller the room, the closer together the original sound and its echo or echoes will be. Go into a cathedral, and you’ll hear how the echo time is increased in proportion to the room’s overall cubic dimension.

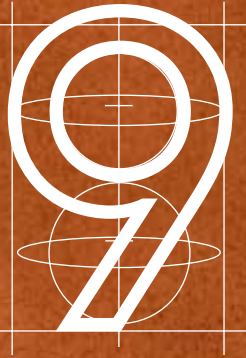

# THE MIXING PROCESS

PRACTICAL ADVICE TO MAKE THE MOST OF YOUR HOME STUDIO MIXES



When creating a final audio mix at home, so many variables go into producing a professional result. It starts with having the best possible sounds recorded to begin with, and hopefully, the first eight chapters of this guide have helped you in that quest. But having great tones recorded can be undermined if your room and your monitors are giving you inaccurate information when it comes time to mix.

## ROOM AND MONITORS

The acoustics in your mixing environment will make a huge difference in your ability to correctly interpret the sounds coming out of your monitors. If you have reflections, or the bass frequencies are being swallowed up, you will find your final mixes can be wildly out of balance when you take them to other listening environments. The first key is to optimize your acoustic environment and the second is to recognize the anomalies your studio presents so you take them into account when producing a mix.

“You can’t go wrong if you use a reference,” says Weiss. “If you’re mixing, and you put on a reference CD and you’re constantly switching between what you’re mixing and this source material, it gives you something to reference at that moment, in that environment, and it helps you avoid mistakes. At a professional level, I don’t know anyone who doesn’t use a reference to help keep their decisions sharp.”

The next piece of the puzzle is having a good set of studio monitors—in fact, more than one pair is the norm in any pro environment. An accurate representation of the tones you’ve recorded is key to making intelligent decisions when you mix.

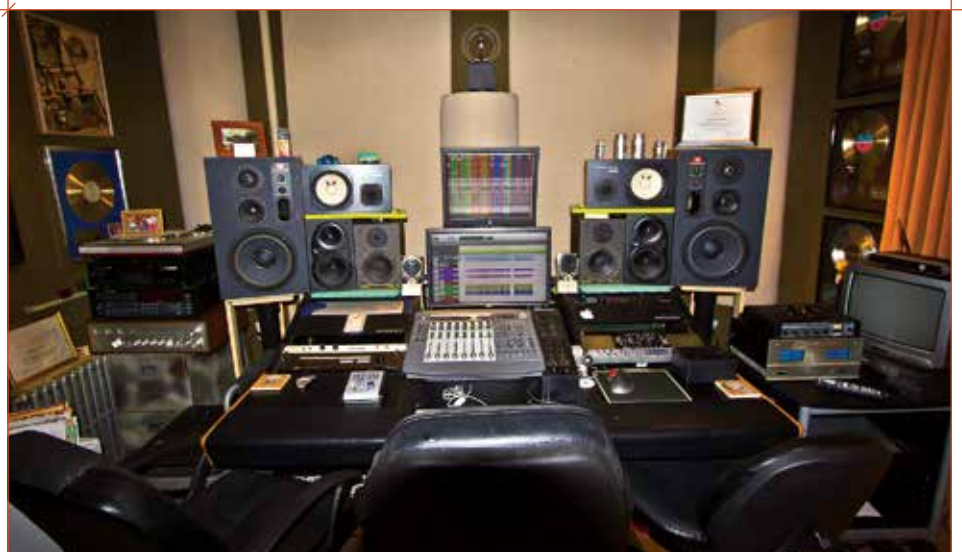

GRAMMY-WINNING ENGINEER MIKE TARSIA'S SET UP IN PHILADELPHIA.  
[WWW.MIKETARSIA.COM](http://WWW.MIKETARSIA.COM)

“When it comes to studio monitors,” advises Raison, “you want something that will give you as clear a vision of your music as possible. Some of the less expensive monitors have the byproduct of being very colored in one direction or another. There are dozens of manufacturers out there that make beautiful, sweet sounding speakers that truly are a lens to the sound, and that’s ultimately what you want.”

As advised in Chapter 1, setting your monitors in relation to your listening position in

as close to an isosceles triangle as possible is one good rule to follow, as is keeping your monitors away from corners. “I always recommend being in the center of the room,” explains Raison, “and if you’re going to drive with big speakers, try to put some kind of absorptive component in the corner. Auralex makes these big wedges, a [LENRD](#) (Low-End Node Reduction Device), which is a low-frequency absorber. Just putting a couple of those in the corners can help tighten the room up.”

“And use multiple listening sources,” says Weiss. “Most studios have multiple sets of monitors, and the reason for that is to make sure things translate well to multiple sources. It’s got to sound good in headphones, on a boom box, on your iPod, your car stereo, in a huge club with mammoth speakers. Switching between smaller monitors and larger ones will give your ears a chance to hear and concentrate on different frequencies during the course of a session.

“In fact, when you’re taking a break, listening to the mix from outside the room or from a completely different vantage point can help you hear things you missed sitting in your regular position at the board. Make a point to let someone else sit in the big chair once in a while and move to another place in the room. Don’t use this technique to mix for EQ, you’re going to have all sorts of artifacts introduced to the mix from a vantage point down the hall, and bass frequencies will probably be more prominent. But it’s a good way to double check your levels.”

### STEREO FIELD

One key element of the mixing process is carving a space for the various instruments and sounds so they fit together into a balanced whole, where each element is individually discernible but contributing to the bigger picture. Putting a mix together is much like piecing together a puzzle, both in terms of the stereo field and the frequency range.

“95% of the time, if you’re trying to meet the normal popular music protocol,” says Raison, “the bass drum, the bass guitar, and the snare drum are right in the middle. But that doesn’t mean it has to be that way. Listen to the Beatles, the Beach Boys, or Radiohead and find bands that have done some radical panning. But the majority of people I know are trying to get on the radio, they’re trying to climb the ladder, they’re trying to get their music out there, so we’re trying to lower the risk, we don’t want to be radical in a case like that.

“From that point, it’s a matter of your art. I’ve spent a lot of time behind the drums, so I have the tendency to mix from the perspective of the drummer, but I’ll never uniformly

pan the toms hard left or right—that’s never been a sexy sound to me. I’ll generally leave the toms between 10 o’clock and 2 o’clock in the panning. The overheads I want radically hard left and hard right, that adds a spaciousness you just can’t create otherwise. I’ll usually bring the hi-hat just a little bit left of center, because the hi-hat is so critical in the majority of songs, and I don’t want that one right smack up the middle.”

Weiss adds that, “One mistake people make is to pan the drums hard right and left, so the hi-hat is somewhere behind your head and the ride cymbal is on the other side and the drums are just taking up too much of the stereo space. The drums are trampling on everything, fighting with the background vocals, fighting with the stereo guitars, etc.”

Another common mistake in mixing is to pan an effect, like reverb, too wide on a given instrument. For a snare drum that’s right in the middle of your mix, don’t automatically pan the reverb hard right and left. For a more natural sound, pan the reverb channels somewhere around 11 and 1 o’clock, so the reverb sits on either side of the snare. If you find that sound is too tight and you want to open the sound up a little more, incrementally open the panning of the reverb.

### ISOLATE FREQUENCIES

The next concept to understand in the mixing phase is that the puzzle isn’t just an issue of panning and the stereo field, but also a matter of fitting the frequencies of the instruments together so they don’t occupy the same space.

“You need to ask yourself, ‘What frequencies are overlapping?’” says Weiss. “It’s just so common with people who are inexperienced, that you’re going to take each instrument and you’re going to solo it, and you’re going to EQ it and add effects and say, ‘Yeah! That’s the bass sound I want!’ Then you put it into the track and the bass sounds terrible. It’s one thing to solo a track to remove a click or a buzz or some specific thing. But when you’re dealing with EQ and effects, you need to listen to the track among multiple instruments to help you to carve out the space.”

One method of streamlining each track to help it occupy your preferred space on the frequency spectrum is to remove the frequencies you don’t need. With a bass guitar, for example, the instrument produces low-end and high-end articulation and you can significantly clean up the track by removing all the high-frequency energy you don’t need.

The same is true with vocals, get rid of the low-frequency information that’s below where you need the vocal to be. This process will remove the noise of the singer bouncing around the studio, or inadvertently hitting the mic stand. It’s going to allow each instrument to be focused, it’s going to really clean up the mix, and that will help it translate to all the different speakers and systems it’s going to be played through.

“If I’m mixing a project I produced,” adds Raison, “I mix it differently than if I’m mixing something someone handed me to mix. If it’s something I produced, I already have a vision, and I approach every move I make to get me closer to my vision. If someone hires me to do a mix, the first thing I do is I go and listen to each track individually to make sure everything is in compliance. I’ll go to the hi-hat and the overheads and roll off the lows. I’ll go to the guitars and make sure they’re appropriately beefy and sound good, and I’ll process the dynamics of the vocals. Then I go back and pair things up. I’ll bring up a kick drum and a bass guitar and I make sure they work in concert with each other, yet remain defined. If it’s multiple guitars, I’ll start bringing the guitars together and I’ll shape the guitars so that each one has its own voice.”

Most instruments have go-to frequencies you can target if you’re trying to boost or control a particular track. For instance, the go-to frequency to pull out of a bass guitar is 250 Hz as that frequency tends to muddy up a mix when combined with guitars, drums, and everything else. You start losing the definition of the individual instruments. Instrument frequencies will overlap each other, so the trick is making room for each instrument. That might involve learning how to “scoop out” the drums to make room for the bass, and scoop out the bass to make room for the



guitar. It's all part of working on the mixing puzzle.

This process also might fly in the face of what you might consider "great tone" from any given instrument. "It's happened to me a lot," says Weiss, "where the bass player wants to solo his track in the mix, and he'll start saying, 'It's got too much of this upper-mid thing going on.' Then you fix it up and put it back in the mix, and it doesn't cut. It needs that upper mid. Soling the bass sound and trying to get it to sound its best on its own is not going to work in almost every situation.

"The sound coming out of the amp isn't always the sound that's going to sit best in the recording. I've had so much trouble with that. I've also had some incredible outcomes, where in the end, the bass player's like 'Wow, that sounds so good in the mix! I totally get why you needed to put that top end on the bass.'"

### VOLUME CONTROL

There are plenty of engineers who insist on feeling the music as much as hearing it, but a general good tip is to get accustomed to mixing and listening to your mixes at a moderate volume level. When the mix is too loud all the time, you will likely experience ear fatigue earlier on, and if it's too low, you'll be straining to hear the different frequencies you need to concentrate on to make good decisions.

That said, turning the mix really low at some points can help you isolate particular elements of the track, including reverb and other effects. If the vocal track or bass or snare drum are noticeably sticking out of your mix at low volumes, it can be an indicator that they are not sitting in the mix correctly. It's also valuable to listen on multiple speakers, and on headphones, as they can really help when choosing the level of reverb and other effects.

### CHANGE UP THE EFFECTS

"As a general rule," says Weiss, "one tip regarding reverb and other effects is not to use the same reverb for all the instruments. If the various instruments were cut in different rooms at different times, you might think

adding the same reverb to everything is going to help it sound like everyone was in the same room. But in actuality, you're not helping the instruments find their own place in the mix that way. You're going to want different reverb on the vocals than on the guitars, and a completely different reverb on the drums than you do on the bass and the rest of the instruments."

### TIGHTENING UP THE PERFORMANCE

"Here's a great trick to tighten up a drum track with the bass," says Weiss. "Let's say you've got a great drum track, and you wish the bass performance was more in sync with the kick drum. Take the bass and put it through a gate. You then take the kick drum



and plug it into the side chain detector circuit of the gate, so when the kick drum is hit, the bass becomes amplified. At first, that's going to sound really bizarre, because the bass will only be heard when the kick drum is hit, and the bass player's probably doing something a little more than just following the kick. So you go to the mix or ratio control and you make sure you're only using maybe 25% of the gated sound of the bass and the other 75% is the original signal. So what's happening is the bass guitar signal is being amplified by 25% every time the kick drum is hit, and that totally tightens up the bass guitar and makes it sit better with the drummer. There are plenty of other uses for this technique, but this really illustrates it well."

### BREADTH

"One thing I do in the big studio that I recommend to the home recording enthusiast," says Raison, "is to cut one good solid bass track and one good solid drum performance. Guitars? Cut it two or three times. And if you

have two acoustic guitar tracks and they're almost identical, hard pan them, and the listener won't recognize them as two separate guitars, but rather as one large guitar with breadth. It's a fantastic technique to add stereo field without making things jump out. That can be a valuable asset to the finished mix.

"In the realm of digital, if you tried the same thing by just copying the same track and then hard pan it, it'll still sound mono or worse. If you delay one track a little bit to add some thickness, it'll sound processed. So I recommend you just cut it one more time. Same goes for vocals. Don't end up with one lead vocal track, end up with two or three lead vocal tracks. That way you can have your main lead vocal, and then you can bring in that double vocal track on certain phrases, or the choruses, or to differentiate the bridge. It all depends on your vision for the project and the needs of the music."

### BUSING

One way to look at a bus is as a sub-mix. Technically, a bus is a combining amplifier that takes multiple sources and puts them through a single source or stereo source. In practice, that translates to being a tool that can be used to control the volume of multiple tracks in a stereo mix with one or two faders. And rather than bouncing or consolidating tracks, where you're actually recording a new track, busing allows you to control a group of tracks while maintaining the individual tracks as they were originally recorded.

When mixing, one way to use a bus is to take all of the drums and mix them to the point where you can raise and lower the volume of the overall drum mix with one or two faders. It makes the rest of the process a lot easier—you can mute the drums with one button and you can do things like compress the bus instead of compressing each individual element, which can make things sound a lot more cohesive.

It's an easier way to mix, particularly when you have a complicated arrangement or a lot of instruments to manage. You can bus drums to a stereo mix, multiple guitar tracks to another stereo mix, and the background

vocals to another. Ultimately, you're working with these various stereo sub-mixes—each of which can have effects, compression, or panning control. If you decide that the drums are too wide, you can modify the panning and tighten them up. Conversely, if they're too confined, you can widen them up.

### EAR FATIGUE

Ear fatigue is one of those nebulous conditions that can occur while recording—and more likely during mix-down—that you may not even recognize is occurring until after the fact. You're in the studio, you think you've nailed the mix, then the next day you pull it up and think, "What the heck were we doing? This sounds terrible."

You probably won't get a physical sensation in your ears when fatigue starts to set in, it's more of an inability to discern particular sounds, especially in the midrange. Everything starts to blend together, and it becomes difficult to determine whether something is sitting correctly in the mix. You pull up the vocal a bit and it sounds too loud, you pull it back and it seems to disappear. That's a warning sign that you're ears are fatigued.

Try to protect your ears in the hours leading up to a session by wearing earplugs or minimizing the amount of sound you are exposed to. Taking frequent breaks is the easiest way to minimize getting fatigued to the point where you're unable to discern frequencies properly. A good rule of thumb is to take a break, maybe 15 minutes every two hours. Get up from the console, grab a cup of coffee, get a bite to eat, make yourself leave the control room and give your ears a rest. When you find yourself turning up the volume to hear what you were having no trouble hearing earlier in the day, that could be a sign of ear fatigue. Sometimes the best decision is to leave a mix in progress and pick it up the next day.

"I've definitely been there, where my ears are fatigued, but not only that, my brain is fatigued and I'm not in a place to make good decisions," admits Weiss. "So it's as much that as the ear fatigue. That's when your creativity starts to fail. You're not thinking 'I want to make this sound as good as possible,' or

thinking about achieving a sound, you're thinking, 'I'm exhausted and I just want to finish this and get out of here.' That's never going to result in your best work."

### FIXING IT IN THE MIX

When you're tracking, the last thing you want to be doing is fixing a technical problem and killing the vibe of the session, but the idea of "fixing it in the mix" is not a mindset you want to get into. It can make the mixing process a lot more complicated and difficult and instead of a mixing session, you're doing a whole lot of clean-up work. That can significantly throw off your timeline and expectations for how long the recording/mixing process will take.

Then again, with computer technology and the use of a click track, post-recording editing can work wonders with your recorded tracks.

"From a production point of view," explains Weiss, "one trick they use in pro studios after



Everything starts to blend together, and it becomes difficult to determine whether something is sitting correctly in the mix. You pull up the vocal and it sounds too loud, you pull it back and it disappears. That's a warning sign that your ears are fatigued.



the recording process is basically cutting and pasting. You take the best chorus and paste it into the vamp of the song, so the listener is hearing that exact same chorus and it sounds really consistent and professional. You can also take a chorus or a vamp that's not impactful enough and bring up the energy by replacing it with a better take.

"Or let's say the first two bars of the drum track are absolutely right on. You can take those first two bars and paste them into every verse so there's consistency in the track. That's an engineering trick that gets used a lot for vocals, guitar, and all sorts of instruments."

Other post-recording options you can employ include creating TV tracks—versions of the song with the vocals removed—or mak-

ing multiple mixes with slight adjustments to the volume of certain instruments. Produce a mix with the vocals where you think they ought to be, then you might push the vocals up a couple dB and record another, and then a third with the vocals down a couple dB.

### MIXING A LIVE RECORD

Mixing a live recording requires a different approach than a studio recording because the environment is so different. The very nature of the live room means you don't have control over isolation—especially in a small venue. If you have a four-piece band, even with discreet tracks from every instrument, you can experience a lot of bleeding from one instrument to the next, or bass and other sounds coming through the monitors filtering into the other tracks.

"You sometimes have to treat a track to get what you want out of it," says Raison. "On a big stage, in a big venue, everything is very different. Everything is miked, instruments

and amplifiers are far enough away from each other that this isn't as much of an issue. In small rooms, you have to deal with the situation. But that's half of the art and the creativity of mixing.

"I had a high-stakes live recording I did, and the vocalist had a massive quantity of wedge monitors around him cranked up to 11. But my biggest problem was the crash cymbals being picked up by his vocal mic. Those cymbals are right at mouth-level and they're loud, bright, brash, and shrill, and the SM58 microphone picked it up. So when it came time to edit and mix that project, it became a real dance of automation, to get the cymbals and the vocals to work well together. And there's nothing you can do about that on a small stage—you've got to deal with what you're dealing with for a live recording."

## MASTERING

After a mix is finished, and typically when an album or EP's worth of material is completed, the finishing step in the recording/mixing process is mastering. Through the use of equalizers, exciters, compressors, maximizers, and other processors, post-production mastering can unify your collective mixes and give them a consistency and boost in volume that the mixing process alone can't achieve.

Most recording software has mastering capabilities, but there's a reason every major-label release is sent to facilities that specialize exclusively in mastering. A fresh pair of ears can be the difference between a good-sounding finished product and a great one. An unbiased [mastering professional](#) will evaluate your master, and he/she will hear things in their environment you won't, especially as you've spent weeks and months recording in your own studio, listening to the tracks and mixes through the same monitors.

Mastering can raise the overall volume level, even out song levels and EQ across all your tracks, correct minor mix deficiencies, eliminate noises and set the spacing between tracks, add CD text info, and more. It's the

last piece of the puzzle in the recording process, and it will make the most of all the hard work and time you put into your home recording.



SPENCE BURTON'S STUDIO IN THE WASHINGTON D.C AREA  
MAKES CREATIVE USE OF A CORNER OF A BASEMENT FOR A MIXING SETUP.

# GLOSSARY

## AMBIENCE

The acoustic quality of a room or area, including the perceived sense of space caused by reflections, reverberations, and the other acoustic attributes in the space.

## AMBIENT

Ambient noise refers to the reflections and reverberations of the original sound source, or other sound sources in the acoustic space.

## AMPLITUDE

Amplitude refers to the acoustic energy or intensity of a sound, related to a sound's power.

## ABSORB

The absorption of sound occurs when sound energy is attenuated (lessened, reduced) when it passes through a medium or strikes a surface. Physically, this is usually the conversion of sound into heat, i.e. sound molecules lose energy upon striking the material's atoms, which become agitated (warm), and so absorption is literally the changing of sound energy to heat.

## ARTIFACT

Any noise added to the original signal from a sound source.

## ATTENUATOR

An electronic device that reduces the power of a signal with negligible distortion to its waveform. Microphones will often have attenuator pads designed to lower the output level and avoid overloads when recording loud audio sources.

## BAFFLE

A sound baffle is a construction or device that reduces the level of a sound, minimizing noise and reverberation.

## BASS TRAP

An acoustic energy absorber designed to dampen low frequencies. Most common are "porous absorbers," which tend toward broadband action, absorbing a wide range of

sound frequencies. Resonating absorbers are narrow band absorbers, targeting a narrower frequency range.

## COMB FILTERING

A sound with a frequency response curve that has multiple peaks and valleys, resembling a comb. This is caused by reflections arriving out of phase with the direct sound, causing cancellations and reinforcements, making some frequencies unnaturally louder and others virtually disappear.

## COMP TRACK

A composite track typically refers to a situation where one final track is composed of elements from two or more tracks. In the case of a vocal comp track, the vocalist may lay down three recordings of the lead performance, and the recording or mixing engineer will take the best phrases from each, cutting and pasting to a new track, made up of the best lines and phrases from the recorded performances.

## COMPRESSOR

A signal processor that reduces the dynamic range of a signal, effectively reducing the output signal level in relation to the input signal level according to ratios relating to user-defined thresholds.

## DECOUPLING

As most sound transfer from inside a room to the outside occurs as vibrations passing directly through solid structural elements (brick, woodwork, etc.), breaking the connection between the noise source and the outside is the most effective way to prevent the transmission of sound. Referred to as decoupling, this typically requires physically detaching structural elements to improve sound isolation. This can be achieved by floating a floor, using rubber, springs, and other isolators; using resilient materials between structural frames, walls, and ceilings; or inserting spaces and air gaps between walls and other partitions.

## DIFFUSE

Widely spread out or scattered. In acoustics, diffusing sound waves reduces the intensity of the reflected waves, making them weaker and harder to distinguish.

## DIRECT SOUND (also incident sound)

The first sound that arrives at a listener.

## EARLY REFLECTION (also first reflection)

After the direct sound, the next to arrive is the first reflected sound waves, and then the early reflections, which take a little longer to reach the listener due to traveling a longer path length.

## EQ

Short for "equalizer," an EQ is an electronic filter that modifies the frequency response of a signal, adjusting the amplitude of a frequency. EQs were originally designed to correct for the losses in the amplitude of frequencies in the transmission in broadcasting and recording.

## FLUTTER ECHO

A flutter echo, which typically occurs in rooms with parallel walls more than 25 feet apart, is an acoustic effect characterized by sound waves reflecting back and forth at a rate of less than 15 per second.

## GAIN STAGING

Gain staging refers to maximizing the gain levels from a given sound source—regardless of the microphone, source, or signal strength—to achieve the lowest-noise performance and the highest level of flexibility from your recording system.

## HIGH PASS FILTER (also low cut filter)

An electronic processor that allows frequencies above a set cut-off frequency to pass through.

## ISOLATING

The isolation of sound is the process by which sound energy is contained or blocked (as opposed to being converted into heat, as hap-

pens in absorption). Typically what someone would mean when they refer to “soundproofing” a room: preventing sound from leaving or entering a space.

### LATENCY

Inherent in signal and software processing, latency refers to the delay in the time it takes for a system or device to respond to an instruction, for a signal to pass through a device, or for a command to be carried out.

### LOW PASS FILTER (also high-cut filter)

An electronic processor that allows frequencies below a set cut-off frequency to pass through.

### LOW-FREQUENCY ROLL-OFF

A circuit that attenuates a signal that is above (low pass filter) or below (high pass filter) a specified frequency. For example, microphones frequently have a bass roll-off filter to remove wind noise and/or excessive breath pops.

### MICROPHONE PREAMP

A microphone preamplifier is an electronic amplifier that prepares a weak electrical signal, such as that from an instrument or mic cable, for further amplification or processing. Using a preamp will help reduce the effects of noise and interference from other sound sources and boosts the signal strength without significantly degrading the signal-to-noise ratio.

### MODE (also standing wave or eigentone)

A mode is a wave of sound that bounces between two (or more) parallel surfaces, emphasizing some frequencies over others, causing a “bump” or “dip” in a room’s frequency response related to the room’s dimension. There are three types of modes: 1) axial modes, standing waves between two parallel surfaces; 2) tangential modes, standing waves between four surfaces; 3) oblique modes, standing waves between six surfaces.

### NODE

A point along a standing wave where the wave has minimal amplitude.

### PHASE CANCELLATION

When two signals have the same time relationship, with the positive and negative amplitudes aligned, they are in phase and will add to one another (summing). If the positive and negative amplitudes offset, they are out of phase and will subtract from one another

(canceling). As with water waves, one wave’s energy grows stronger when waves collide in phase, and weaker when they collide out of phase.

### PICKUP PATTERN (also polar pattern)

A microphone’s pickup pattern refers to the breadth of its area of concentration, i.e., how sensitive the microphone is to picking up a sound source relative to its central axis.

### REFLECTION

Just as with light, the reflection of sound follows the law of reflection (the angle of incidence equals the angle of reflection). Reflected sound waves can interfere with incident waves, producing interference which leads to standing waves.

### REVERBERATION

Reverberation is the sound remaining in a room after the original sound source is silent (the time it takes the sound energy to decay is called the reverberation time).

### SIBILANT

A sound characterized by a prominent hissing, specifically an “ess” or “shh.”

### SIGNAL-TO-NOISE RATIO

Usually expressed in decibels, the signal-to-noise ratio (S/N) is an audio measurement of the residual noise of a unit, such as a power amplifier or preamp.

### SOFT LIMIT

Related to compression, applying a soft limiter will allow a digital signal to be recorded several dB hotter while not sounding overly compressed as only the peaks are “rounded off.”

### SOURCE MONITORING

The process of reviewing a recorded track for tone, mix, and sound quality through your recording set up. Often used to ensure mic placement and EQ settings are optimal in the course of recording a track.

### TRANSIENTS

A high amplitude sound, short in duration, that occurs at the beginning of a sound wave, e.g. the sound of a pick on a guitar string.

### TRANSMIT

Transmission refers to sound or vibration being transferred from inside a room to the outside, typically via mechanical means (directly through solid elements like brick and wood).

Transmission occurs when the vibration meets with a wall, ceiling, or floor, and the vibration is amplified and heard in the second space.

## BIOGRAPHIES

**ANDRE CALILHANNA** is a writer, editor, and musician who manages and contributes regularly to the [Disc Makers](#) and [BookBaby](#) blogs. He has recorded and released numerous albums and EP using many of the techniques outlined in this guide.

**DREW RAISON** is a producer, studio owner, and expert in studio management and development. [drewraison.com](#)

**JON MARC WEISS** is the Senior IT Systems Engineer for Disc Makers and also an accomplished recording engineer, studio designer, and musician with over 20 years’ experience. He owns and operates [Kiva Productions](#) right outside of Philadelphia in Hollywood, PA to develop local and national acts.

**KEITH HATSCHEK** is Director of the Music Management Program at the University of the Pacific (Stockton, CA) and is a regular contributor to the [Disc Makers Blog](#). He’s authored two books: [The Golden Moment: Recording Secrets of the Pros](#), and [How To Get a Job in the Music Industry](#).

**BARBARA ADAMS** is the house engineer at Philadelphia’s Tin Angel and also works as a sound engineer at World Cafe Live! Adams also occasionally works as a freelance engineer/system tech and does freelance work mixing for regional bands touring the Northeast and Mid-Atlantic states. Adams is also owner and business manager of [BurnDown Studios](#) in Germantown, PA and an Adjunct Professor of Sound Reinforcement at Drexel University and Rowan University.

Much of the information in this glossary was adapted from [Rane’s Pro Audio Reference](#) and [Wikipedia](#).